

Lighting

Solar Inverters

Energy Meters

EMI / EMC Filters

Industrial Electronics

Medical Electronics

Switch Mode Power Supply

Battery Chargers/ UPS/ Inverters

Induction Welding Applications/ Heating Applications



Product Catalogue

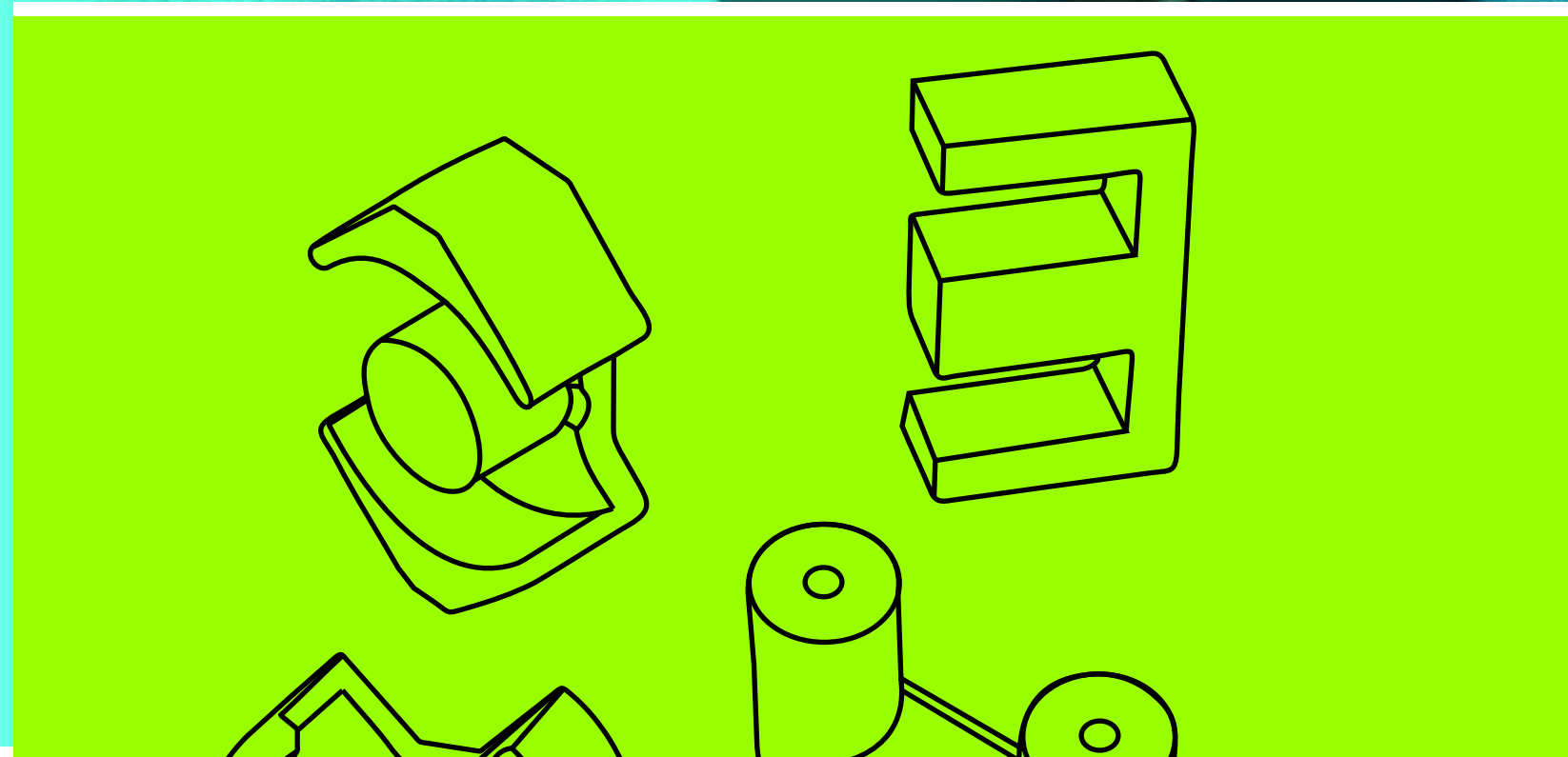

COSMO FERRITES LIMITED

www.cosmoferrites.com

Head Office : Office No. 517, 5th Floor, Block A, DLF Towers, Jasola,
New Delhi 110 025 INDIA

Tel. : +91 11 49398800, 49398803

Fax : +91 11 49398888

E-mail : sales@cosmoferrites.com, delhi@cosmoferrites.com

Works : Jabli, Distt. Solan, Himachal Pradesh - 173 209 (INDIA)

Tel : +91 1792 277231/32/36, Fax : +91 1792 277234,

E-mail : plant@cosmoferrites.com



COSMO FERRITES LIMITED, INDIA



COSMO FERRITES LIMITED [CFR], an ISO 9001:2008 & ISO 14001:2004 certified company, for its production process & commitment towards clean environment. Founded in 1986 by promoters with over five decades of standing in the Indian Industry, is today the leading manufacturer of Soft Ferrites in India. The Company has its unit operating in the foothills of the Himalayas at a distance of 300 Kms. from Delhi, Capital of India.

State of the art equipment from leading manufacturers of Europe, rigorous quality standards and well equipped in-house R&D set up ensures delivery of high quality ferrites to our customers along with continuous product up gradation. The Company places overriding value on developing close and long lasting relationships with its customers. Wealth of experience, technical capabilities and resources to support the design and development activities enable Cosmo to deliver customized ferrites on time.

COSMO FERRITES has a leading position in the Indian soft ferrites market. It pioneered the exports of Soft Ferrites from India in 1988 and has been the leading exporter of soft ferrites since then. More than 70% of production is exported to all over the world.

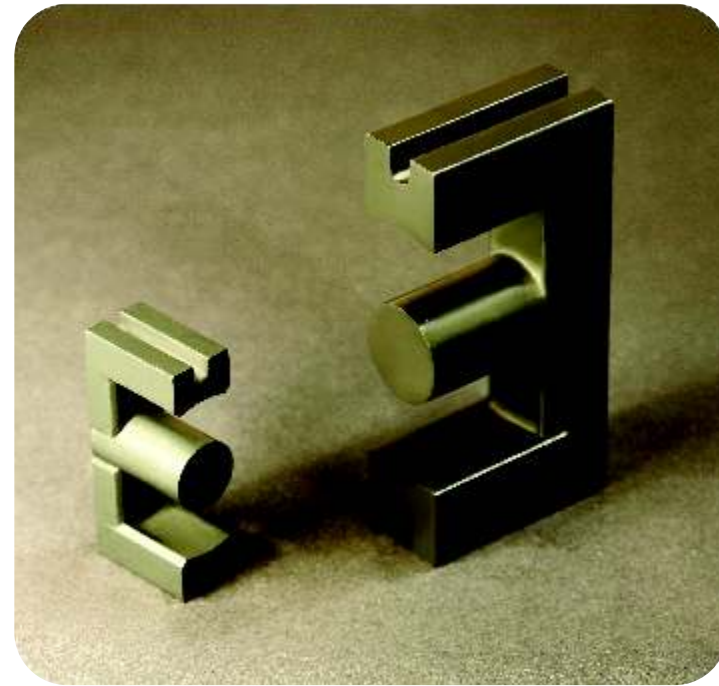

APPLICATIONS SERVED BY CFR RANGE



LIGHTING :

- Electronic Ballast for CFL Lamps
- Electronics Chokes for Tubular Lamps

POWER CONDITIONING :

- UPS/Inverter transformers
- Welding transformers
- Switch Mode Power Supplies
- Medical Electronics
- Telecom Power Supplier Introduction

EMI FILTERS / CHOKES / SENSORS

- EMI / EMC Chokes
- Energy Meters

ULTRASONIC APPLICATIONS SOLAR INVERTER

COSMO PRODUCT PROFILE

PRODUCT	RANGE
RING CORES (TOROIDS)	T0603 TO T152
UU CORES (FLAT)	UU10 TO UU126
UU CORES (VERTICAL)	UU35 TO UUR64
EE CORES	EE10 TO EE128
EI CORES	EI 22 TO EI40
I CORES	I 30 TO I 100
EC CORES	EC35 TO EC90
ETD CORES	ETD29 TO ETD59
EER CORES	EER28 TO EER53
EFF CORES	EFF15 TO EFF30
EVD CORES	EVD15 TO EVD25
EP CORES	EP 7 TO EP20
PQ CORES	PQ20 TO PQ32
PM CORES	PM62 TO PM87
POT CORES	POT9 TO POT36
ROD CORES	ROD 3 TO ROD 8
PLANNER	EI18P TO EI64P

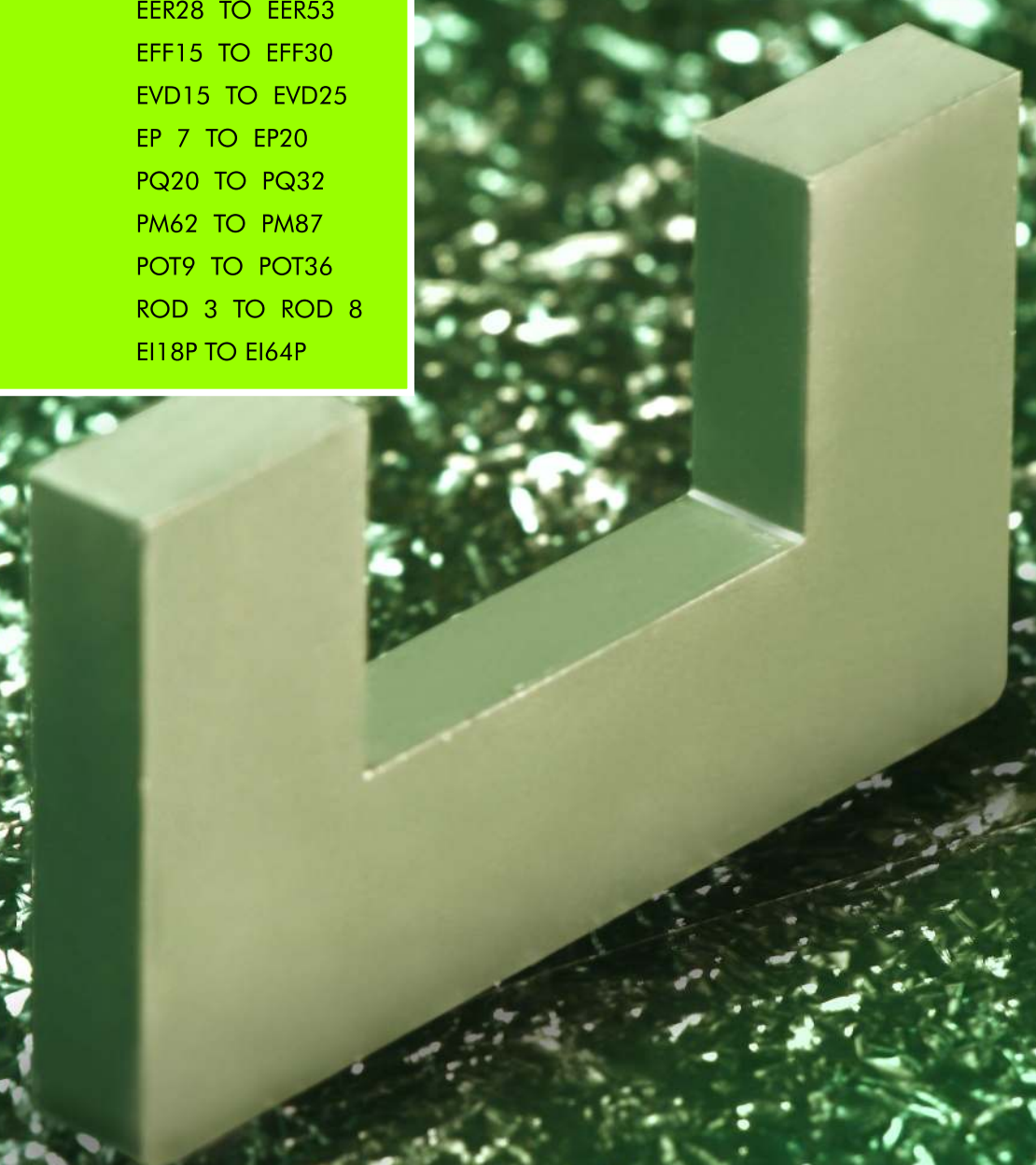

NOTE : CAPS AND BOBBINS IN UL APPROVED MATERIAL CAN BE ARRANGED ON ORDER



	SYMBOL	UNIT	TEMP. (°C)	MATERIAL															
				CF196	CF139	CF297*	CF295	CF124	CF140	CF130	CF195A*	CF255*	CF265	CF190	CF197	CF275*	CF199		
INITIAL PERMEABILITY ±20%	μ_{ac}	-	25	2000	2100	2300	3000	2500	2500	3000	5000	5500	5000	6000	7000	7000	9000		
SATURATION FLUX DENSITY	B_s	mT	25	500	490	518	525	490	390	520	400	440	460	400	400	420	400		
	(H=1kA/m)		100	400	390	410	410	390	310	410	260	310	320	280	260	240	260		
RESIDUAL FLUX DENSITY	B_r	MT	25	210	-	-	80	200	110	200	-	-	150	150	150	-	150		
COERCIVITY	H_c	A/m	25	16	21	21	-	16	24	15	12	12	12	10	12	240	8		
POWER LOSS DENSITY	Pc (16KHz) 200 mT	Kw/m ³	25	≤120	-	-	-	≤100	-	-	-	-	-	-	-	-	-	-	
			100	≤110	-	-	-	≤90	-	-	-	-	-	-	-	-	-	-	-
	Pc (25KHz) 200 mT	Kw/m ³	25	≤160	-	-	-	≤150	-	-	-	-	-	-	-	-	-	-	-
			100	≤140	-	-	-	≤130	-	-	-	-	-	-	-	-	-	-	-
	Pc (100KHz) 100 mT	Kw/m ³	25	-	-	-	-	-	-	-	-	-	-	-	-	-	-	-	-
			100	-	≤60	≤50	-	-	-	-	-	-	-	-	-	-	-	-	-
Pc (100KHz) 200 mT	Kw/m ³	25	-	-	-	400	-	-	-	-	-	-	-	-	-	-	-	-	
		100	-	≤380	≤350	350	-	-	-	-	-	-	-	-	-	-	-	-	-
Relative Loss Factor	$\tan \delta / \mu_{ac} \times 10^{-6}$	(10KHz)	25	-	-	-	-	-	-	≤2.5	≤5.0	≤5.0	≤5.0	≤5.0	≤7.0	≤5.0	≤20		
		(100KHz)	25	-	-	-	-	-	≤2.5	-	≤20	≤15.0	≤25.0	< 40	-	≤25	-		
Hysteresis Mat. Constant	η_b	X10 ⁻⁶	25	-	-	-	-	-	≤0.4	-	≤03	≤0.3	≤1.5	≤1.5	-	≤0.3	≤0.3		
Relative Temp. Coefficient	α_f	X10 ⁻⁶	25-55	-	-	-	-	-	0.4-1.5	-	-	0.5-2.0	-	-	-	0.5-2.0	-		
Disaccommodation Factor	D_f	X10 ⁻⁶	25	-	-	-	-	-	≤3.0	-	-	-	-	-	-	-	-		
Sec. Max Permeability	SPM	°C	-	70-90	90-110	90-110	-	60-80	-	50-70	-	-	-	-	-	-	-		
CURIE TEMPERATURE	T_c	°C	-	≥200	≥210	≥210	≥ 210	≥220	≥150	≥200	≥120	≥150	≥160	≥120	≥120	≥130	≥115		
RESISTIVITY	ρ	Ωm	25	0.4	8	8	8	0.5	1.0	0.4	0.5	0.5	0.2	0.5	0.2	0.2	0.1		
DENSITY	d	Kg/m ³	25	4.8 X 10 ³	4.8 X 10 ³	4.8 X 10 ³	4.8 X 10 ³	4.8 X 10 ³	4.8 X 10 ³	4.8 X 10 ³	4.8 X 10 ³	4.8 X 10 ³	4.8 X 10 ³	4.8 X 10 ³	4.8 X 10 ³	4.8 X 10 ³	4.8 X 10 ³		

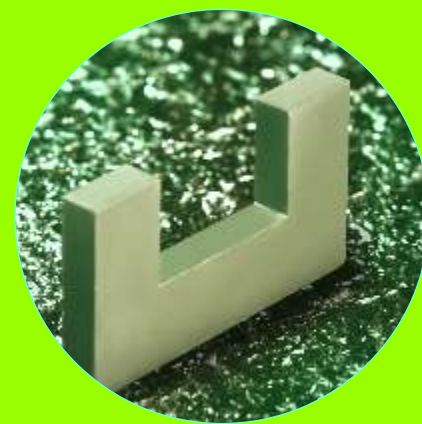

Note :

1. Material data specified here have been derived from measurements on Toroidal Cores T2512.
2. * New materials
3. As per the Company's policy for continuous improvement in the product portfolio, the right to change materials, core designs etc. At any time without notice is reserved.
4. Initial permeability, relative loss factor and Curie temperature are measured at f=10KHz and B=0.1mT.
5. Disaccommodation factor-Done 10 minutes and 100 minutes after demagnetization.



Type	Fig	Dimensions (mm)			Effective Parameters		AL (nH)+30% -20%							AL (nH) ±30%
		A	B	C	Le(mm)	Ae(mm²)	CF196	CF139	CF130	CF265	CF195/ 195A	CF190	CF197	CF199
T15268	2	152.0±3.0	68.0±1.36	20±0.4	310.9	796.1	6400	6700	9600	16000	16000	19300	-	-
T15222	2	152.0 ±5.0	104±3.60	22.0±0.50	392.6	521.7	3300	3500	5000	8350	8350	10000	11700	-
T15219	2	152.0±5.0	104.0±3.6	19.0±0.5	392.6	450.6	2900	3000	4300	7200	7200	8600	10100	10800
T15215	2	152.0 ±5.0	104 ±3.60	15.0 ±0.50	392.6	355.7	2300	2400	3400	5700	5700	6800	7950	9600
T14025	2	140±3.0	103±2.0	25±1.0	375.8	458.9	3000	3200	4600	7600	7600	9200	10700	-
T10725	2	107±2.0	65.0±1.3	25.0±0.75	259	514.2	5000	5200	7400	12400	12400	-	-	20000
T10225	2	102.0 ±2	65.8 ±1.3	25.00 ±0.70	255.3	445.3	4500	4700	6700	11200	11200	13400	15300	-
T10222	2	102.0 ±2	65.8 ±1.3	22.00 ±0.50	255.3	391.9	3850	4000	5800	9600	9600	11500	13500	-
T10221	2	102.0 ±2	65.8 ±1.3	21.00 ±0.50	255.3	374.1	3700	3800	5500	9200	9200	11000	12400	-
T10220	2	102±2.0	65.8±1.3	20.0±0.5	255.3	356.3	3500	3700	5200	8700	8700	10500	12300	-
T10218	2	102.0 ±2	65.8 ±1.3	18.00 ±0.50	255.3	320.6	3200	3300	4800	7950	7950	9500	11000	-
T10215	2	102.0±2.0	65.8±1.3	15.0±0.5	255	262	2550	2700	3850	6400	6400	7700	9000	10300
T10020	2	100.0±3.0	55.0±1.5	20.0±0.6	229.6	436.8	4800	5000	7200	11950	11950	14300	16700	19100
T8756	2	87.0±1.2	56.0±1.0	12.7±0.5	217.5	193.7	2200	2350	3350	5600	5600	6700	7800	-
T8720	2	87.4 ±1.35	54.0 ±1.0	20.0 ±0.45	213.8	327.6	3850	4000	5800	9600	9600	11500	13400	16400
T8714	2	87.4±1.35	54.0±1.0	13.8±0.45	213.8	226.1	2650	2800	4000	6600	6600	7900	9300	11300
T8530	2	85.0±1.5	62.0±1.5	30.0±1.0	227.1	342.2	3800	4000	5700	9450	9450	11300	13200	18900
T8520	2	85.0±1.5	62.0±1.5	20.0±1.0	227.1	228	2450	2600	3700	6200	6200	7400	8700	-
T8515	2	85.0 ±1.50	62.0 ±1.5	15.0±1.00	227.1	171.1	1900	2000	2800	4700	4700	5700	6600	8000
T8022	2	80.0±1.5	50.0±0.9	22.0±1.0	196.9	324	4100	4300	6200	10300	10300	12400	14400	-
T8020A	2	80.0 ±2.5	40.0 ±1.2	20.0 ±0.5	174.2	384.4	5500	5800	8300	13800	13800	16600	19400	-
T8020	2	80.0 ±1.50	50.0±0.90	20.0±1.00	196.9	294.5	3750	3950	5600	9400	9400	11200	13100	-
T8015A	2	80.0±2.5	40.0±1.2	15.0±0.5	174.2	288.3	4160	4400	6200	10400	10400	12500	14500	16600
T8015	2	80±1.5	50±0.9	15±0.5	196.9	220.9	2800	2900	4200	7000	7000	8400	9800	12000
T7313	2	073.7±1.5	38.9±0.8	12.7±0.5	165.4	213.6	3250	3400	4800	8100	8100	9700	11400	13000
T6325	2	63.0±1.3	38.0±0.8	25.0±0.5	152.08	305.93	5050	5300	7600	12600	12600	13900	16400	20200
T6320	2	63.0 ±1.30	38.0±0.80	20.0±0.50	152.1	244.7	4000	3900	6000	10100	9300	-	13000	-
T6318	2	63.0 ±1.30	38.0±0.80	18.5±0.50	152.1	226.4	3700	3900	5600	9300	9300	-	-	-
T6315	2	63.0±1.3	38.0±0.8	15.05±0.4	152.1	184.2	3000	3200	4500	7600	7600	9100	10600	-
T6313	2	63.0±1.3	38.0±0.8	12.7±0.3	152.1	155.4	2550	2650	3850	6400	6400	7700	9000	-
T6113	2	61.0±0.9	35.6±0.9	12.7±0.3	144.6	157.4	2700	2900	4100	6800	6800	8200	9600	11600
T6020	2	60.0 ±1.00	30.0±0.80	20.0±0.50	130.7	288.3	5500	5800	8300	13800	13800	-	-	-
T5818A	2	58.3±1.0	32±0.7	18.5±0.5	133.7	236.1	4400	4600	6600	11000	11000	13200	15460	19900
T5818	2	58.3±1.0	40.8±0.8	17.6±0.5	152.4	152.4	2400	2500	3600	6300	6300	7550	8800	11300
T5806	2	58.3±1.00	40.8±0.80	6.0±0.40	152.4	51.9	850	900	1300	2100	2100	2600	3000	3850
T5618	2	56.0±1.2	32.0±0.65	18.0±0.5	131.3	210.5	4000	4200	6000	10000	10000	12000	14100	-

*Toroids available in UL approved coated material

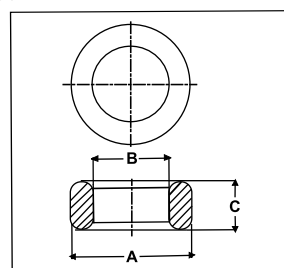

FIG 1

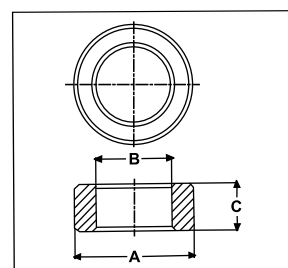

FIG 2

Type	Fig	Dimensions (mm)			Effective Parameters		AL (nH)+30% -20%							AL (nH) ±30%
		A	B	C	Le(mm)	Ae(mm²)	CF196	CF139	CF130	CF265	CF195/ 195A	CF190	CF197	CF199
T5110	2	50±1.5	15±0.5	10±0.5	81.1	155.3	4800	5000	7200	12000	12000	14400	16800	21600
T5030	2	50.0±1.0	34.0±0.8	30.0±0.6	128.7	237	4600	4850	6950	11500	11500	13800	16200	18500
T5025	2	50.0 ±1.00	34.0±0.8	25.0±0.5	128.7	197.5	3850	4050	5800	9600	9600	11500	13500	-
T5020	2	50.0±1.0	30.0±0.65	20.0±0.5	120.4	195.7	4100	4300	6100	10200	10200	12200	14300	17300
T5019	2	50.0±1.0	34.0±0.8	19.0±0.5	128.7	150.1	2900	3100	4400	7300	7300	8800	10200	12500
T4919	2	49.0±1.0	31.8±0.7	19.0±0.5	123.1	160.9	3300	3450	4900	8200	8200	9800	11500	14000
T4518	2	45.0 ±1.35	28.0-0.8	18.0±0.40	110.5	150.2	3400	3600	5100	8500	8500	10200	11900	-
T4516	2	45.0 ±1.35	28.0 ±0.8	16.0±0.4	110.5	133.5	3000	3200	4500	7600	7600	9100	10600	13600
T4511	2	45.0±1.35	28.0±0.8	11.0±0.4	110.5	91.8	2100	2200	3100	5200	5200	6200	7300	10400
T4218	2	42.0±0.6	21.0±0.5	18.5±0.4	91.5	186.7	5100	5400	7700	12800	12800	15300	17900	-
T4218A	2	41.8±1.0	26.2±0.6	18.0±0.5	103	137.9	3400	3500	5000	8400	8400	10100	11700	-
T4212	2	41.8±1.0	26.2±0.6	12.5±0.3	103	95.7	2300	2450	3500	5800	5800	7000	8200	-
T4016	2	39.9±0.6	24.1±0.5	16.0±0.3	96.4	123.8	3200	3400	4800	8000	8000	9700	11300	13700
T3829	2	38.0 ±0.60	22.0±0.45	29.0±0.50	89.7	226.3	6300	6600	9500	15800	15800	17400	20600	25000
T3821	2	38.1 ±0.70	19.0±0.50	21.0±0.50	82.8	192.7	5850	6100	8700	14600	14600	16000	-	-
T3819A	2	38.0±0.6	22.0±0.45	18.5±0.35	89.7	144.4	4000	4200	6000	10100	10100	12100	14100	-
T3819	2	38.1±0.7	25.4±0.5	19.0±0.4	97.1	119	3050	3200	4600	7650	7650	9200	10700	-
T3816	2	38.1±0.7	25.4±0.5	15.8±0.4	97.1	98.9	2500	2600	3750	6400	6400	7700	8950	11500
T3813	2	38.1±0.5	25.4±0.5	12.7±0.2	97.1	79.5	2000	2100	3000	5000	5000	6000	7200	9250
T3813A	2	38.1±0.7	19.0±0.5	12.9±0.4	82.8	118.34	3500	3700	5300	8900	8900	10800	12400	15900
T3618	2	36.0 ±0.70	23.0±0.50	18.0±0.40	89.6	95.9	2700	2800	4000	6700	6700	8000	9400	12100
T3617	2	36±0.7	23±0.5	17±0.4	89.7	108.7	3050	3200	4550	7600	7600	9100	10600	-
T3615	2	36.0±0.7	23.0±0.5	15.0±0.4	89.6	95.89	2700	2800	4000	6700	6700	8000	9400	12000
T3421	2	34.0±0.70	21.8±0.50	21.0±0.40	84.8	126	3700	3900	5600	9300	9300	11200	13000	16800
T3415	2	34.0±0.70	21.8±0.50	15.0±0.30	84.8	90	2650	2800	4000	6650	6650	8000	9300	12000
T3115	2	31.5±1.0	19.0±0.6	15.0±0.4	76	91.78	3100	3250	4650	7700	7700	9100	10600	13650
T3113	2	31.0(+0.8,-0.5)	19.0±0.6	13.0±0.5	75.49	76.46	2550	2650	3800	6350	6350	7650	8900	11450
T3112	2	31.5±1.0	19.0±0.6	12.5±0.4	76	76.5	2500	2650	3800	6300	6300	7600	8800	11350
T3109	2	31.5 ±1.00	19.0±0.6	9.5±0.4	76	58.1	1900	2000	2850	4800	4800	5800	6700	8650
T3106	2	31.5±1.0	19.0±0.6	6.35±0.3	76	38.9	1300	1350	1900	3200	3200	3850	4500	5800
T2915	2	29.6±0.7	18.4±0.6	14.9±0.4	72.6	81.9	2850	2950	4250	7100	7100	8500	9900	12700
T2910	2	29.50±0.70	18.40±0.60	10.0±0.40	72.5	54.5	1900	2000	2800	4700	4700	5650	6600	8500
T2908	2	29.6±0.7	18.4±0.6	8.5±0.4	72.6	46.71	1600	1700	2400	4000	4000	4850	5650	7250
T2907	2	29.6±0.70	18.4±0.60	7.5 ±0.30	72.6	41.2	1400	1500	2100	3500	3500	4300	5000	-
T2820A	2	27.5±0.6	14.9±0.4	20.0±0.4	62.6	122.1	4900	5150	7300	12200	12200	14700	17100	-
T2815	2	28.0 ±0.70	14.0±0.50	14.9±0.40	61	100.2	4100	4300	6200	10300	10300	-	-	-
T2813A	2	27.5±0.6	14.9±0.4	13.0±0.4	62.6	79.4	3200	3350	4800	8000	8000	9500	11100	14300

*Toroids available in UL approved coated material



Type	Fig	Dimensions (mm)			Effective Parameters		AL (nH)+30% -20%							AL (nH) ±30%
		A	B	C	Le(mm)	Ae(mm ²)	CF196	CF139	CF130	CF265	CF195/ 195A	CF190	CF197	CF199
T2715	2	27.9±0.6	19.0±0.4	15.0±0.4	71.9	65.9	2300	2400	3450	5700	5700	6900	8000	10300
T2620	2	26 ±0.55	14.5 ±0.35	20.0±0.3	60.1	111.8	4700	4900	7000	11600	11600	14000	16300	21000
T2615	2	26.0±0.55	14.5±0.35	15.0±0.3	60.1	83.8	3500	3650	5250	8750	8750	10500	12200	15750
T2610	2	26.0±0.55	14.5±0.35	10.0±0.3	60.14	55.9	2250	2350	3400	5700	5700	7000	8200	10500
T2520	2	25.0±0.5	15.05±0.5	20.0±0.5	60.3	97.4	4000	4300	6100	10100	10100	12100	14200	-
T2515	2	25.0±0.5	15.05±0.5	15.0±0.5	60.29	73.04	3050	3200	4550	7600	7600	9100	10600	13700
T2513	2	25.0±0.5	15.05±0.5	13.0±0.5	60.29	63.3	2600	2750	3950	6600	6600	7900	9200	11900
T2512	2	25.0±0.5	15.05±0.5	12.0±0.5	60.29	58.4	2350	2450	3500	6100	6100	7300	8500	10950
T2510	2	25.0±0.5	15.05±0.5	10.0±0.5	60.29	48.7	2050	2100	3000	5100	5100	6100	7100	9100
T2506F	2	25.4±0.6	15.5±0.5	6.35±0.25	61.7	30.8	1250	1300	1900	3100	3100	3750	4400	5600
T2212A	2	22.1±0.4	13.7±0.3	12.7±0.4	54.15	53.34	2450	2600	3700	6200	6200	7400	8650	11000
T2212	2	22.1±0.40	13.7±0.30	12.0±0.40	54.1	49.5	2300	2400	3400	5700	5700	6900	8000	10300
T2210	2	22.1±0.40	13.7±0.3	10.0±0.35	54.15	43.5	2000	2100	3000	5000	5000	6050	6700	9100
T2210B	2	22.1±0.4	13.8min	10±0.35	54.15	41.21	2000	2100	2850	4800	4800	5750	6700	8600
T2208	2	22.1±0.4	13.7±0.3	8.0±0.3	54.15	32.97	1600	1700	2400	3800	3800	4590	5350	6900
T2206	2	22.1±0.4	13.7±0.3	6.35±0.3	54.15	26.17	1200	1300	1800	3000	3000	3600	4200	5450
T2112	2	20.75±.25	13.0±0.5	12±0.3	51.1	45.7	2200	2300	3400	5500	5500	6600	7700	9800
T2106	2	21.0±0.5	13.0±0.5	6.0±0.5	51.4	23.5	1150	1200	1700	2850	2850	3400	4000	5200
T2104	2	21.0±0.40	13.2±0.50	4.1±0.25	51.8	15.7	750	800	1100	1900	1900	2300	2700	3400
T2010	2	20.0±0.4	10.0±0.25	10.0±0.4	43.6	48	2750	2900	4150	6900	6900	8300	9700	12400
T2008	2	20.0±0.4	10.0±0.5	8.0±0.4	43.6	38.41	2200	2300	3300	5500	5500	6600	7700	9900
T2007	2	20.0±0.4	10.0±0.25	7.0±0.3	43.6	33.6	1950	2000	2900	4850	4850	5800	6800	8700
T1912	2	19.0±0.4	10.8±0.3	12.1±0.4	44.4	48.3	2700	2800	4100	6800	6800	8200	9500	12500
T1910	2	19.0±0.40	10.8±0.30	10.0±0.30	44.4	39.9	2250	2350	3350	5650	5650	6750	7900	10100
T1908	2	19.0±0.4	10.8±0.3	8.0±0.25	44.4	31.9	1800	1900	2700	4500	4500	5400	6320	8100
T1904	2	19.0±0.40	10.8±0.30	3.4±0.25	44.4	13.6	750	800	1150	1900	1900	-	-	-
T1812	2	17.5±0.50	11.05±0.30	12.0±0.40	43.3	38	2200	2300	3300	5500	5500	6600	7700	9900
T1810	2	17.5 ±0.5	11.05 ±0.3	10.0±0.3	43.3	31.7	1850	1950	2750	4600	4600	5500	6450	8250
T1808	2	17.5±0.50	11.05±0.30	8.0±0.20	43.3	25.4	1450	1550	2200	3700	3700	4400	5150	6600
T1807	2	17.5±0.5	11.05±0.3	7.0±0.2	43.3	22.2	1200	1250	1950	3200	3200	3850	4500	5800
T1806	2	17.5±0.5	11.05±0.3	6.0±0.2	43.3	19	1100	1150	1650	2750	2750	3300	3850	4950
T1805	2	17.5±0.50	11.05±0.30	5.0±0.20	43.3	15.8	900	950	1400	2300	2300	2750	3200	4100
T1611	2	16.0 ±0.5	8.0 ±0.4	11.0 ±0.4	34.8	42.3	3050	3200	4600	7600	7600	9100	10700	13700
T1608	2	16.0±0.5	9.6±0.4	8.0±0.3	38.5	25.1	1600	1700	2450	4100	4100	4900	5700	7350
T1607	2	16.0±0.40	9.6±0.30	7.0±0.20	38.5	22	1400	1500	2150	3600	3600	4300	5000	6450
T1606	2	16.0±0.4	9.6±0.3	6.3±0.2	38.5	19.73	1300	1350	1950	3200	3200	3900	4500	5800

*Toroids available in UL approved coated material

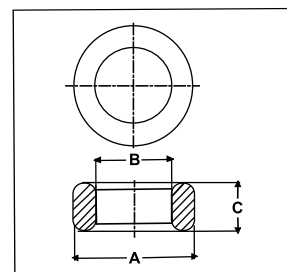

FIG 1

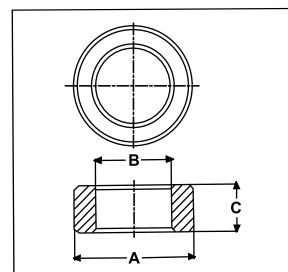

FIG 2

Type	Fig	Dimensions (mm)			Effective Parameters		AL (nH)+30% -20%							AL (nH) ±30%
		A	B	C	Le(mm)	Ae(mm ²)	CF196	CF139	CF130	CF265	CF195/ 195A	CF190	CF197	CF199
T1605	2	16.0±0.4	9.6±0.3	5.0±0.2	38.5	15.7	1025	1075	1550	2600	2600	3100	3600	4600
T1528	2	15.15±0.50	9.15±0.40	28.15±0.40	37.3	78.1	5300	5500	7900	13100	13100	15800	18400	23700
T1407	2	14.0±0.3	9.0±0.2	7.0±0.2	35	17.2	1200	1300	1850	3100	3100	3700	4300	5550
T1407S	2	14.0±0.3	8.0±0.25	7.0±0.2	35.0	17.2	1200	1300	1850	3100	3100	3700	4300	-
T1405	2	14.0±0.3	9.0±0.2	4.9±0.2	35	12.05	880	900	1325	2250	2250	2700	3100	4000
T1306A	1	12.9±0.25	7.9±0.2	6.2±0.2	31.4	15.2	1200	1250	1825	3050	3050	3650	4250	5500
T1306	2	13.0±0.4	7.0±0.3	6.0±0.3	29.5	17.4	1500	1550	2200	3700	3700	4400	5200	6650
T1305	2	13.0±0.4	7.0±0.3	5.0±0.3	29.5	14.5	1200	1250	1800	3000	3000	3700	4300	5600
T1305A	2	12.9±0.25	7.9±0.2	5.0±0.2	31.4	12.25	980	1030	1450	2450	2450	2950	3450	4400
T1303	2	13.0±0.4	7.0±0.3	3.2±0.2	29.5	9.3	800	825	1200	1950	1950	2350	2700	3500
T1206	2	12.5±0.40	7.5±0.40	6.0±0.30	30.1	14.7	1200	1300	1850	3100	3100	3700	4300	5500
T1205	2	12.5±0.4	7.5±0.4	5.0±0.3	30.1	12.2	1000	1100	1500	2500	2500	3050	3550	4600
T1007	2	10.0±0.30	6.0±0.25	7.0±0.30	24.1	13.7	1400	1500	2100	3550	3550	4300	5000	6400
T1005A	2	10.0±0.3	5.5±0.2	4.5±0.3	23	9.8	1050	1125	1600	2700	2700	3200	3700	4800
T1005	2	10.0±0.30	6.0±0.25	5.0±0.30	24.1	9.8	1000	1050	1500	2550	2550	3050	3550	4600
T1004	2	10.0±0.3	6.0±0.2	4.0±0.3	24.1	7.83	800	850	1200	1900	2000	2400	2800	3600
T1003	2	10.0±0.30	6.0±0.25	3.0±0.30	24.1	5.9	600	650	900	1550	1550	1850	2150	2800
T0910F	2	9.50±0.25	4.90±0.15	10.4±0.25	21.05	23	2800	2900	4200	7000	7000	8250	9650	12500
T0906	2	9.53±0.30	4.75±0.20	6.00±0.20	20.7	13.77	1700	1750	2500	4200	4200	5000	5900	7500
T0905	2	9.53±0.30	4.75±0.20	5.18±0.20	20.7	11.9	1450	1500	2150	3600	3600	4300	5050	6500
T1806	2	17.5±0.5	11.05±0.3	6.0±0.2	43.3	19.1	1100	1150	1650	2800	2800	3300	3900	5000
T0904	1	9.53±0.30	4.75±0.20	3.80±0.20	20.7	8.75	1050	1100	1600	2650	2650	3200	3700	4800
T0903	1	9.53±0.3	4.75±0.2	3.18±0.2	20.7	7.3	850	900	1300	2100	2100	2500	3000	4000
T0804	2	8.00±0.30	4.0±0.20	4.00±0.20	17.4	7.69	1100	1150	1600	2700	2700	3250	3800	4900
T0705	2	7.6 ±0.2	3.4 ±0.1	5.0 ±0.2	15.6	10	1550	1600	2300	4000	4000	4800	5600	7200
T0704A	2	7.6 ±0.2	3.4 ±0.1	4.1 ±0.2	15.55	8.16	1250	1350	1900	3300	3300	3950	4600	5900
T0704	2	7.62±0.38	3.18±0.38	4.78±0.25	15	10	1700	1750	2500	4200	4200	5000	5850	7500
T0702A	2	7.2±0.20	3.3±0.20	2.30±0.20	14.93	4.26	650	700	950	1800	1800	1950	2300	2900
T0603A	2	6.3±0.25	3.8±0.15	3.20±0.15	15.21	3.92	650	700	950	1600	1600	1950	2250	2900
T0603	2	5.85±0.28	3.05±0.28	3.18±0.25	13	4.3	800	900	1250	2100	2100	2500	2900	3700
T0602	2	5.85 ±0.28	3.05±0.28	2.50±0.25	13	3.4	650	700	1000	1600	1600	2000	2300	2900
T2609	2	26.0±0.5	17.9±0.35	9.0±0.3	67.4	36	1300	1400	2000	3350	3350	4000	4700	6000

*Toroids available in UL approved coated material



E Cores

Type	Fig	Dimensions (mm)						Effective Parameters		AL (nH)+30% -20%			
		A	B	C	D	E	F	Le(mm)	Ae(mm ²)	CF196	CF139	CF130	CF195
EE12820	3	130±3.0	89.0 min.	63.0±1.0	43.0±0.5	40.0±1.0	20.0±1.0	285.4	792.7	6100	6400	-	-
EE11036	3	110±2.5	74.2 min.	56.0 ±1.0	37.2 ±1.4	36.0±1.0	36.0±1.0	245.2	1294	11400	11900	-	-
EE10028	3	100.3±2.0	73.2±1.4	59.5±0.5	46.8±0.8	27.5±0.5	27.6±0.5	274.1	739.6	5900	6200	-	-
EE10021	3	100.3±2.0	73.2±1.4	59.5±0.5	46.8±0.8	27.5±0.5	20.62±0.5	274.1	552.6	4700	5000	-	-
EE8040	3	80.0±0.9	60.3±0.9	38.1±0.33	28.53±0.33	19.8±0.3	39.6±0.4	185.1	774.6	8500	8700	-	-
EE8025	3	80.0±0.9	60.3±0.9	38.1±0.33	28.53±0.33	19.8±0.3	25.0±0.4	185.1	489	5400	5700	-	-
EE8020	3	80.0±0.9	60.3±0.9	38.1±0.33	28.53±0.33	19.8±0.3	19.8±0.3	185.1	387.3	4300	4500	-	-
EE7219	3	72.4±1.45	53.35±1.1	27.95±0.15	18.05±0.25	19.05±0.38	19.05±0.38	137	367.9	5900	6200	8300	-
EE7091	3	70.0±1.5	48.5min.	45.5±0.5	35.5±0.5	19.5±0.5	19.5±0.5	204	386	4300	4500	-	-
EE7032	3	70.5±1.0	48.75±0.75	32.95±0.25	22.25±0.35	21.65±0.35	31.6±0.4	149.9	683	9000	9400	-	-
EE6527	3	66.5-2.7	44.2+1.8	32.5±0.3	22.2+0.7	20.0-0.7	27.4-0.8	147	532	7800	8100	-	-
EE6513	3	66.5-2.7	44.2+1.8	32.5±0.3	22.2+0.7	20.0-0.7	13.7-0.6	147	266	4000	4200	5600	-
EE5541	3	55.1±1.1	38.1±0.75	27.5±0.15	18.8±0.4	16.85±0.3	40.95±0.75	123.4	705.2	12300	12800	-	-
EE5525	3	55.0+1.2-0.9	37.5+1.2	27.8-0.6	18.5+0.8	17.2-0.5	25.0-0.6	120	422	7600	7900	-	-
EE5521	3	55.0+1.2-0.9	37.5+1.2	27.8-0.6	18.5+0.8	17.2-0.5	21.0-0.6	120	354	6350	6400	8800	-
EE5017	3	51.0-1.4	34.0+0.8	17.0-0.5	9.2±0.2	14.5±0.3	11.75±0.5	80.7	183.2	4600	4750	-	-
EE4716	3	47.15±0.5	31.6 min.	19.7±0.13	12.1 min.	15.65±0.2	15.65±0.2	89.6	236.8	5700	6000	8000	-
EE4220	3	42.0+1.0-0.7	29.5+1.2	21.2-0.4	14.8+0.7	12.2-0.5	20.0-0.8	97	240	5400	5700	7600	-
EE4215	3	42.0+1.0-0.7	29.5+1.2	21.2-0.4	14.8+0.7	12.2-0.5	15.2-0.5	97	181	4000	4100	5700	-
EE4112	3	40.7 ±0.7	28.55 min.	16.4±0.2	10.55±0.2	12.4±0.3	12.4±0.3	77.5	146.6	4100	4300	5600	-
EE4012	3	41.0+0.7-0.5	28.5+0.7	17.4+0.5	10.25±0.25	12.0-0.7	12.0-0.7	79	153	4000	4100	-	-
EE3313	3	33.3±0.5	23.6±0.4	23.3±0.3	19.05±0.3	9.7±0.3	12.7±0.3	104.1	118.8	2600	2700	3750	5750
EE2504	3	25.05±0.5	17.9±0.4	11.15±0.25	7.55±0.25	7.25±0.25	4.5±0.2	52.1	32.3	1300	1350	1800	2600
EE1011A	3	10.6±0.3	7.5 min	5.7±0.3	4.4±0.2	2.5±0.2	4.5±0.3	25.97	11.79	-	900		
EE1011B	3	10.8±.3	7.7 min	5.7±0.3	4.4±0.2	2.5±0.2	5.0±0.2	25.97	11.79	-	900		
EE1910B	3	19.2±0.4	14.4±0.3	8.2±0.3	5.8±0.2	5.95±0.25	9.0±0.3	31	61.6	-	2300		
EE1605A	3	16.0+0.7-0.5	11.3+0.6	5.7±0.12	3.9±0.15	4.55±0.15	4.5±0.2	28.6	19.1	-	1050		
EE1607C	3	16.1±0.6	11.6±0.3	6.0±0.2	4.0±.2	4.55±0.15	7.15±0.25	29.7	30.7	-	1700		
EE1607N	3	16.1±0.6	11.6±0.3	8.05±0.15	5.9±0.2	4.55±0.15	7.1-0.4	37.6	30.8	-	1700		
EEL1605D	3	16.2±0.4	11.7 min	7.30±0.3	5.4±0.3	4.0±0.2	4.8±0.2	35.1	19	-	1050		

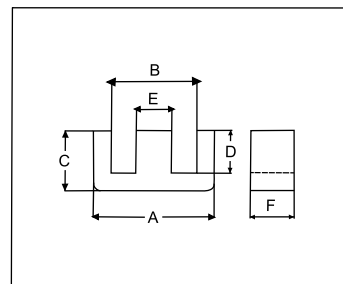

FIG. 3

Type	Fig	Dimensions (mm)						Effective Parameters		AL (nH)+30% -20%			
		A	B	C	D	E	F	Le(mm)	Ae(mm ²)	CF196	CF139	CF130	CF195
EE3611	3	36.4±0.7	25.2±0.7	17.8±0.2	12.15±0.15	9.45±0.25	11.25±0.25	80.8	118	3100	3250	-	-
EE3512	3	35.0+0.8-0.5	25.0+0.8	14.65±0.55	9.0+0.3	10.3-0.6	12.0-0.6	67.3	120	3700	3900	5100	-
EE3512A	3	34.3±0.7	26.0±0.5	14.1±0.2	9.8±0.2	9.3±0.2	12.7±0.25	69	113	3400	3550	4700	
EE3510	3	35.0±0.5	25.0±0.5	17.50 ±0.25	12.50 ±0.25	10.0±0.3	10.0±0.3	80.7	100	2650	2800	3700	-
EE3327	3	33.3±0.5	23.6min.	13.7+1.0	9.9+1.0	9.7±0.3	12.7±0.3	66.4	112.7	3600	3700	-	-
EE3213	3	31.9±1.0	22.77±0.17	14.0±0.4	9.65±0.25	8.9±0.25	12.7±0.3	66.4	113.2	3500	3600	-	-
EE3211	3	32.05±0.75	23.2±0.5	16.1±0.3	11.5±0.3	9.2±0.3	10.65±.35	74.3	96.6	2800	2900	-	-
EE3209	3	32.05±0.75	23.2±0.5	16.1±0.3	11.5±0.2	9.2±0.3	9.15±0.35	74.3	83	2500	2600	3500	5250
EE3109	3	30.9±0.5	22.2±0.4	13.1±0.15	8.6±0.3	9.4±0.25	9.4±0.3	61.3	84.8	3000	3150	4100	-
EE3014	3	30.1±0.7	19.9±0.4	15.0±0.2	10±0.3	6.95±0.25	14.6-0.5	67.0	122.0	-	3500	-	-
EE3012	3	30.1±0.7	19.9±0.4	15.0±0.2	9.7+0.5	6.95±0.25	12.6-0.5	65.5	104.6	3300	3450		
EE3011	3	30.0±0.6	20.2±0.5	13.15±0.2	8.13±0.2	10.7±0.3	10.7±0.3	57.9	108.7	4000	4200	5600	-
EE3007	3	30.0+0.8-0.6	19.5+0.8	15.2 -0.4	9.7+0.6	7.2-0.5	7.3-0.5	67	60	1850	1900	-	-
EE2811	3	28.2±0.4	19.2±0.4	10.6±0.3	6.6±0.2	7.1±0.4	10.7±0.3	49.5	84.4	3600	3750	4950	7100
EE2532	3	25.3+0.5-0.3	19.3+0.4-0.2	15.9±0.2	12.7±0.3	6.5+0.3-0.25	7.0-0.5	73.5	42	1250	1300	1800	2700
EE2525	3	25.4±0.5	18.7min	9.65±0.3	6.65+0.2-0.15	6.3±0.2	25.0±0.35	48.9	155.8	5800	6000	-	-
EE2511	3	25.0+0.8-0.7	17.5+0.8	12.8-0.5	8.7+0.5	7.5-0.5	11.0±0.3	57.5	84.7	3150	3300	-	-
EE2507	3	25.0+0.8-0.7	17.5+0.8	12.8-0.5	8.7+0.5	7.5-0.5	7.5-0.6	57.5	52.5	1800	1900	-	-
EE2507V	3	25.05±0.75	19.0min	12.55±0.25	8.95±0.25	7.25±0.25	7.2±0.3	57.5	52.5	1800	1900	-	-
EE2506M	3	25.45±0.65	19.2±0.4	9.78-0.15	6.78-0.3	6.3±0.2	6.25±0.25	49.2	38.8	1650	1700		
EE2506	3	25.4±0.7	19.6±0.6	9.5±0.2	6.5±0.2	6.3±0.25	6.3±0.25	48	40	1600	1700	2200	3050
EE2105	3	20.6±0.5	16.4±0.4	8.5±0.2	6.2±0.2	4.8±0.2	4.8±0.2	43.5	21.6	900	950	1250	-
EE2011S	3	20.4-0.8	14.1+0.8	10.1-0.4	7.0+0.4	5.9-0.4	11.0 ±0.25	44.9	65.22	2900	3100	4100	5850
EE2005A	3	20.0±0.4	14.6±0.3	10.95±0.15	8.25±0.15	5.65±0.15	5.6±0.20	50.5	30.7	1250	1300	1750	2550
EE2005S	3	20.4-0.8	14.1+0.8	10.1-0.4	7.0 +0.4	5.9-0.4	5.9-0.5	44.9	33.5	1400	1450	1900	2650
EE2005K	3	20.0+0.7-0.4	12.8+0.7-0.4	10.2-0.4	6.3+0.5	5.2-0.4	5.3-0.4	43	31	1350	1400	1800	2500
EE1910A	3	19.1±0.4	14.0min.	8.0±0.18	5.7 min	4.75±0.2	9.5 ±0.20	40.1	45.5	2100	2300	2800	3800
EEL1605D	3	16.20 ±0.40	11.70 min.	7.30 ±0.30	5.40 ±0.30	4.00 ±0.20	4.80 ±0.20	35.10	19.00	-	1100	-	-
EE1906B	3	19.00 ±0.40	14.00 min.	8.00 ±0.13	5.70 ±0.13	4.80 ±0.20	5.50 ±0.20	39.20	26.60	-	1400	-	-
EE1905A	3	19.0±0.4	14.3±0.3	8.0±0.13	5.7±0.13	4.8 ±0.2	4.8±0.20	39.6	22.5	1150	1200	1550	2200
EE1905S	3	19.0±0.3	14.5±0.3	7.9±0.2	5.6±0.15	4.7-0.5	5.2-0.4	39.3	22.7	1050	1100		2000
EE1905	3	19.3±0.3	14.0±0.3	7.9±0.2	5.5-0.2	5.2-0.5	5.2-0.5	38	25	1200	1250	1750	2500
EEL1905	3	19.0±0.3	14.0±0.3	13.55±0.2	11.3±0.3	4.85±0.25	4.85±0.25	61.7	23.4	800	850	1100	1700
EE1906A	3	19.00 ±0.40	14.00 min.	8.00 ±0.13	5.70 ±0.13	4.80 ±0.20	6.50 ±0.25	39.70	30.30	-	1600	-	-
EE1609D	3	16.2±0.4	11.7min	7.3±0.3	5.4±0.3	4.0±0.2	9.9±0.3	35.8	39.3	2000	2200	-	-
EE1608	3	16.0 ±0.5	10.6±0.2	8.1±0.2	5.4±0.2	3.8±0.2	8.0-0.5	37.6	35	1800	1900	-	-
EE1605	3	16.0+0.7-0.5	11.3+0.6	8.2-0.3	5.7+0.4	4.7-0.3	4.7-0.4	37.6	20.1	1000	1050	1450	1850
EEL1605	3	16.0±0.3	12.1±0.3	12.45±0.2	10.25+0.2	4.0±0.2	4.8±0.2	55.6	19.3	700	750	1000	1500
EEL1605B	3	16.1±0.6	12.1±0.3	6.95±0.15	5.4±0.2	4.0±0.2	4.8±0.2	34.9	17.3	950	1000	1300	1800
EE1404	3	13.95±0.35	10.8±0.3	7.65±0.15	5.4±0.2	4.15±0.15	4.15±0.15	33.9	15.5	850	900	1200	1600
EE1306	3	12.65±0.45	9.2±0.3	6.5-0.2	4.5+0.3	3.7-0.3	6.3-0.3	29.6	22.4	1450	1500	1850	2600
EE1306B	3	13.0±0.35	10min	6.0±0.15	4.6±0.2	2.75 ±0.2	6.15±0.15	30.1	17.1	1000	1050	-	1800
EE13 ⁰⁴	3	12.65±0.45	9.2±0.3	6.5-0.2	4.5+0.3	3.7-0.3	3.7-0.3	29.6	13	800	850	1100	1500
EE1011	3	10.2±0.3	7.8±0.3	5.55 ±0.15	4.15±0.15	2.4±0.2	5.0-0.3	25.4	12	850	900	1100	1500



Type	Fig	Dimensions (mm)					Effective Parameters		AL (nH)+30% -20%			
		A	B	C	D	F	Le(mm)	Ae(mm ²)	CF196	CF139	CF130	CF195
UU14130	16	141±5.0	50.0 min	78.5±0.5	33.5±1.0	30±1.0	377	1350	7800	8000	-	-
UU12620	16	126.0±4.0	70.0±2.0	91.0±1.0	63.0±2.0	20.0±0.6	480	560	2700	2800	-	-
UU12643	16	126.0±4.0	70.0±2.0	91.0±1.0	63.0±2.0	43±0.8	486.1	972	4600	4800	-	-
UU12020	16	120 ± 2.5	60.0 ± 1.20	45.0 ± 0.50	15.0 ± 0.5	20.0 ± 0.60	274.2	600	5150	5400	-	-
UU10130	16	10.9±0.9	45 min	76±0.5	48±0.9	30.6±0.6	368	840	5500	5600	-	-
UU10015	16	101.6±2.0	49.0 min.	57.1±0.4	31.7±0.7	25.2±0.7	306	620	4500	4700	6350	-
UU100A	16	101.6±2.00	49.0 min.	57.5±0.40	31.7 ±0.40	12.7 ±0.38	308	321	2500	2600	-	-
UU9352	16	93.0±1.8	36.2±1.2	52.0±0.5	24.0±0.5	30.0±0.6	256	838		7400		
UU9330	16	93.0±1.8	36.2±1.2	76.0±0.5	48.0±0.9	30.0±0.6	354	840	4700	5500	-	-
UU9330B	16	93.0 ± 1.8	34.6 min	76.0 ± 0.50	48.0 ± 0.90	30.0 ± 0.50	354	840	-	5500	-	-
UU9330C	16C	93.0±1.8	36.2±1.20	76.0 ± 0.50	48.0 ± 0.90	30.0 ± 0.60	-	-			-	-
UU9320	16	93.0 ± 1.8	34.6 min	76.0 ± 0.50	48.0 ± 0.90	20.0 ± 0.50	355	560	-	3700	-	-
UU9316	16	93.0 ± 1.8	37.0±1.2	76.0±0.8	48.0±0.8	16.0±0.6	354	448	2700	2800	3700	-
UU9115	16	91.28±2.03	18.26±1.6	66.04±1.32	36.52±0.6(Web)	15.87±0.63	253	612	-	5000	-	-
UU8804	16	88.0 ± 1.2	26.0 ± 0.6	44.0 ± 0.6	31.0±0.4 (Web)	4.0 ± 0.2	-	-	-	-	-	-
UU8407	16	84.0±1.0	41.5 min	7.1±0.2	3.8±0.2	63.0±1.0	106.4	237.6	4700	4900	-	-
UU8310	16	83.0±1.0	33.5 min	9.6±0.2	6.0±0.2	58.5±1.0	94.0	245.1	-	5700	-	-
UU8020	16	80.0±2.0	40.0±0.8	49.0±0.5	29.0±0.3	20.0±0.5	258.8	400	3600	3900	-	-
UU7020	16	68.4±1.6	28.4±0.6	57.5±0.5	37.5±0.5	20.0±0.5	269.8	400	3450	3600	5000	7800
UU6204	16	62.0 ± 0.7	16.0 ± 0.3	31.0 ± 0.5	23.0±0.3 (Web)	4.0 ± 0.2	-	-	-	-	-	-
UU6060	16	59.5±0.80	29.2±0.70	55.0 ± 0.25	40.0 ± 0.60	28.0±0.80	265.8	228.8	2000	2100	-	-
UU6015	16	59.5±0.8	29.2±0.7	55.0±0.25	40.0±0.6	15.25±0.5	265	228	1900	2100	2900	4500
UU4730	16	47.0±0.6	31.0 min	25.0±0.5	10.0±5.0	30±0.6	161.8	570.1	-	6000	-	-
UU4628	16	46.8±0.7	17.5 min.	39.5±0.25	25.5±0.75	28.0±0.8	182.8	397.7	4700	4900	6600	-
UU4628A	16C	46.8±0.70	17.0 min	39.5 ± 0.25	25.5 ± 0.75	28.0 ± 0.80	182.8	397.7	-	-	-	-
UU2537	16	24.5±0.7	9.9±0.3	18.4±0.5	10.85±0.25	7.55±0.25	86.5	53.9	1250	1300		2750
UU2515	16G	25.4±0.40	14.5 min	7.7 ± 0.15	4.7 ± 0.20	7.5 ± 0.20	66.3	40.45	1300	1400		-
UU2332	16	23.0±0.60	8.0±0.30	15.7 ± 0.30	8.5 ± 0.25	7.55 ± 0.25	74	61	1800	1900		3850
UU2130A	16	21.0±0.6	6.3±0.3	15.8±0.25	8.75±0.25	7.5±0.3	70.2	54.3	1550	1650	2100	3000
UU2130	16	21.0±0.6	6.3±0.3	15.3±0.5	8.25±0.25	7.5±0.3	68	55	1600	1650	2150	-
UU2036	16	20.0±0.40	8.0 ± 0.40	18.0 + 0.30 - 0.20	12.0 ± 0.20	6.0 ± 0.20	82.8	36	950	1000		2100
UU1928	16	19.55±0.40	7.15±0.20	-	7.55 ± 0.50	4.75 ± 0.18	63.98	29.45	1000	1050		
UU1910	16	18.5±0.40	7.1 min	11.6 ± 0.20	7.3 ± 0.60	7.0 ± 0.30	59.6	40.22	1450	1500		
UU1620	16	16.0±0.2	7.0±0.3	10.6±0.2	6.0±0.15	6.0±0.15	52	27	950	1000	1300	1700
UU1522	16	15.2±0.7	5.2±0.3	11.1±0.5	6.1±0.35	6.45±0.25	48	32	1300	1350	1750	2400
UU1116	16	10.5±0.2	5.5±0.2	7.9±0.2	5.3±0.15	5.0±0.15	40	13	650	700	900	1300
UU1016	16	10.1±0.2	4.3±0.2	8.2±0.2	5.2±0.2	2.9±0.2	38.4	8.6	450	475	600	850
UU6616	16	66±0.8	33.0±0.8	60.5±0.3	44.0±0.5	16.5±0.3	293.8	272.3	2250	2300	-	-

Geometry	FIG	Dimensions (mm)									Effective Parameters		AL (nH)+30% -20%		
		A	B	C	D	E	E1	E2	F	G	Le(mm)	Ae(mm ²)	CF196	CF139	CF124
UUR6440	16A	64.05±1.95	23.0min.	40.5±0.2	26.5±0.4	-	20.05±0.2	5.05±0.25	24.0±0.3	9.6±0.45	210	290	3200	3300	3800
UUR5536	16B	54.9±1.1	20.0±0.4	37.5±0.25	25.5±0.4	23.5±0.45	-	-	36.0±0.7	12.0±0.4	188	418	5200	5500	6400
UU5972	16 H	50.5±1.0	26.5±1.0	35.8±0.2	21.9±0.5	17±0.4	-	-	4.5±0.2	-	189	210	2600	2650	3200
UU5756	16D	49.8±0.8	27.9±1.0	28.4±0.2	16.0±0.4	15.5±0.4	-	-	15.9±0.4	-	163	171	2350	2450	2900
UU4718	16E	47.4±0.8	19.5±0.6	24.5±0.2	15.8±0.2	13.2±0.3	-	-	14.7±0.3	18.0±0.4	145	153		2450	-
UU3549	16F	35.0 ± 0.50	17.3 min	24.5 + 0.30 - 0.20	16.9 + 0.30 - 0.20	9.6 ± 0.30	-	-	7.6 ± 0.30	-	128.1	73	1300	1400	-
UU3562	16F	35.25±0.50	13.2 min	30.8±0.30	20.5±0.40	12.7±0.20	-	-	9.30±0.30	-	141.4	113.5	1900	2000	-
UU3544	16F	34.75±0.50	13.8 min	21.9±0.30	12.5±0.5	11.5 ± 0.30	-	-	9.5±0.30	-	108	101.6	2150	2250	-
UU2840	16F	278±0.4	9±0.4	21.2±0.20	13.3±0.3	11.2 ± 0.30	-	-	7.5±0.30	-	99.8	105	2400	2500	-

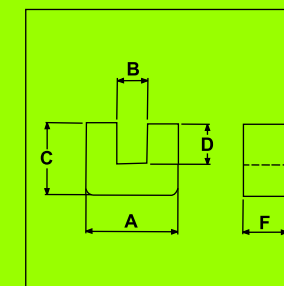

FIG. 16

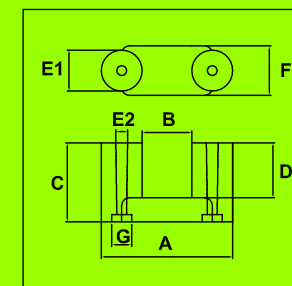

FIG. 16A

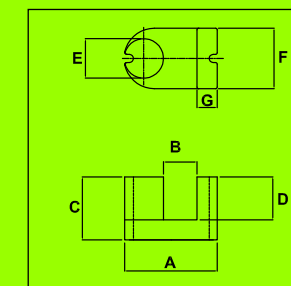

FIG. 16B

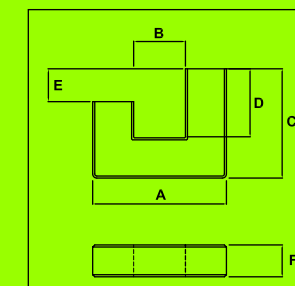

FIG. 16C

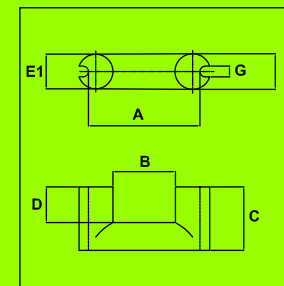

FIG. 16D

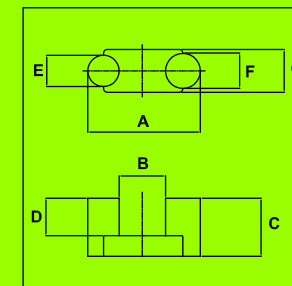

FIG. 16E

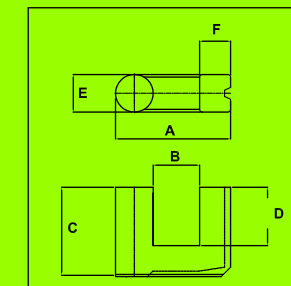

FIG. 16F

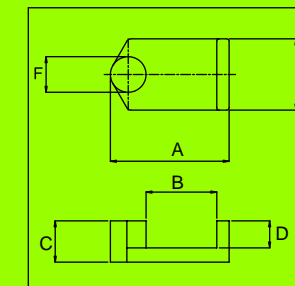

FIG. 16G

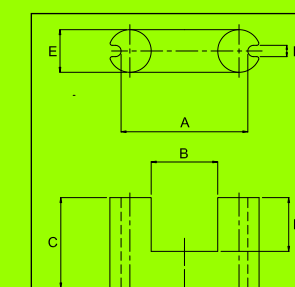

FIG. 16H



EVD, EFC CORES

Type	Fig.	DIMENSIONS (mm)							Effective Parameters		AL (nH)+30% -20%		
		A	B	C	D	E	F	G	Le(mm)	Ae(mm ²)	CF196	CF139	CF130
EVD2513S	18	25.0±0.8-0.7	19.2±0.4	12.6±.25	9.55±.25	8.8±.25	12.7-0.5	8.3±0.3	60	73	-	2450	-
EVD2513	18	25.0±0.8-0.7	19.2±0.4	12.6±0.25	9.55±0.25	8.8±0.25	12.7-0.5	8.3±0.3	60	73	2600	2700	3700
EVD1509	19	14.9±0.6	11.1±0.3	8.85±0.15	6.2 +0.2	5.6±0.2	6.8±0.2	4.6±0.2	38.7	27.7	1400	1500	-
EFC2508	20	25.1±0.4	21.0 min.	12.5±0.2	9.0 ±0.2	11.5±0.2	8.0±0.2	3.95±0.15	59.2	46.4	1700	1750	-

EI CORES

Type	Fig.	DIMENSIONS (mm)							Effective Parameters		AL (nH)+30% -20%			
		A	B	C	D	E	F	G	Le(mm)	Ae(mm ²)	CF196	CF139	CF130	CF195
EI 4012	21	40.0±0.5	27.2+1.0	27.2+0.5	20.0+0.5	12.0-0.7	12.0-0.7	7.5±0.3	76.8	148	3800	3950	5100	-
EI3512T	21	35.0±0.8-0.5	25.0±0.8	23.8+0.7	18.0+0.6	10.3-0.6	11.7±0.3	5.5±0.2	67.3	120	3500	3600		
EI3313	21	33.0±0.5	23.2+0.8	23.3±0.3	19.05±0.35	9.7±0.3	12.7±0.3	5.0±0.2	66.9	118.1	3500	3600	4600	
EI3011	21	30.0±0.7-0.2	20.0±0.7	21.0±0.6	16.0±0.6	11.0 -0.7	11.0-0.7	5.5±0.2	58.5	110.4	3700	3800	4800	
EI2811	21	28.0±0.4	18.6+0.8	17.3±0.3	12.8±0.2	7.5 -0.8	11.0-0.6	3.5±0.2	49.5	84.4	3400	3600	4600	6600

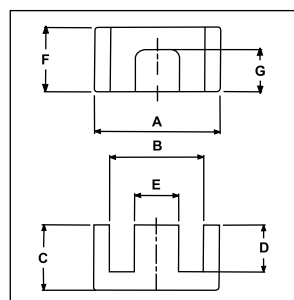

FIG. 18

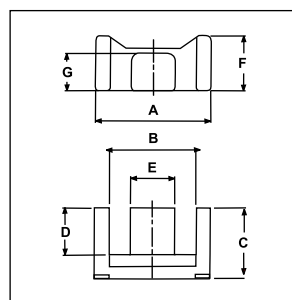

FIG. 19

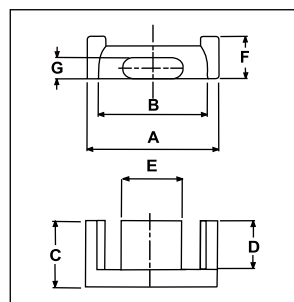

FIG. 20

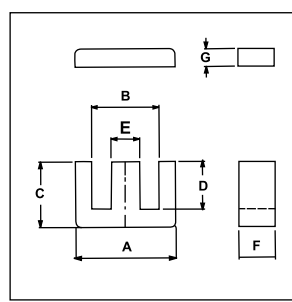

FIG. 21

I - BAR CORES

Type	Fig	Dimensions (mm)		
		A	F	G
I13040	17	130±1.0	40±0.5	25±0.5
I12620	17	126.0±4.0	28.0±1.00	20.0±0.60
I125100	17	125±4.0	100±0.4	10±0.2
I10610	17	106±1.2	25.4±0.4	10±0.2
I10013A	17	101.6±0.25	25.4±0.38	12.7±0.40
I1003A	17	101.6±1.2	25.4±0.5	3.14±0.2
I10075N	17	100.0±0.8	74.6±0.6	5.0±0.2
I10025	17	101.6±2.0	25.4±0.8	25.4±0.8
I9330	17	93.0±1.8	27.5±0.6	30.0±0.6
I9328	17	93.0±1.80	50.0±0.90	28.0±0.50
I9320	17	93.0±1.8	27.5 ±0.5	20.0 ±0.6
I9318	17	93.0±1.80	50.0±0.90	18.0±0.50
I9316	17	93.0±1.8	27.5±0.6	16.0±0.6
I8625	17	86.0 ±2.0	25.4±0.8	25.4 ±0.8
I8330	17	81.0 ±1.20	30.0±1.00	28.0 ±1.1
I8020	17	80.0±0.5	20.0±0.8	20.0±0.4
I7625	17	76.00±0.5	25.4±0.3	25.4±0.3
I7020	17	70.0±0.5	30.0±0.6	20.0±0.6
I6540	17	65.0±1.0	40±0.5	25±0.5
I6204	17	62.0±0.6	31.0 ±0.5	4.0 ±0.4
I6030	17	60.0±1.0	28.0±0.5	30.0±0.5
I6015	17	59.5±0.80	15.25±0.50	15.25±0.50
I6004	17	60.0 ±0.6	23.0±0.5	4.0 ±0.4
I5905	17	59.5±0.3	14.5±0.3	4.8±0.2
I5814	17	58.0±0.2	54.0±0.2	14.0±0.2
I5509	17	55.0±0.2	44.0±0.2	9.0±0.2
I5405	17	54.5±0.3	14.5±0.3	4.8±0.2
I5125	17	51.45±0.2	25.4±0.2	25.4±0.2
I3030	17	30.0±0.6	30.0±0.5	27.5±0.5
I3016	17	30.0±0.6	16.0±0.5	27.5±0.5
I2830	17	30.0±0.40	28.0±0.40	18.5±0.20
I2525	17	25.0±0.40	25.0±0.40	25.0±0.40
I2020	17	19.8±0.30	20.0±0.20	19.8±0.30
I2010	17	19.8±0.30	20.0±0.20	9.85±0.30

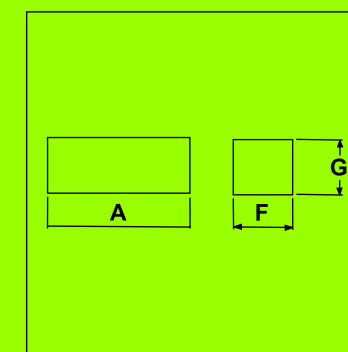

FIG. 17



EFF CORES

Type	Fig	Dimension (mm)							Effective Parameters		AL (nH)+30% -20%	
		A	B	C	D	E	F	G	Le(mm)	Ae(mm ²)	CF196	CF139
EFF3009	8	30.0±0.8	22.4±0.75	15.0±0.15	11.2±0.3	14.6±0.25	9.1±0.2	4.9±0.15	68	69	2000	2100
EFF2509	8	25.0±0.65	18.7±0.6	12.5±0.15	9.3±0.25	11.4±0.2	9.1±0.2	5.2±0.15	57	58	2000	2050
EFF2309	8	22.8±0.5	16.8±0.4	15.0±0.15	11.0±0.15	10.0±0.25	8.6±0.25	4.5±0.15	65	56.5	1700	1800
EFF2007	8	20.0±0.55	15.4±0.5	10.0±0.15	7.7±0.25	8.9±0.2	6.65±0.15	3.6±0.15	47	31	1200	1350
EFF2007	8	20.0±0.55	15.4±0.5	10.0±0.15	7.7±0.25	8.9±0.2	6.65±0.15		47	31		1350
EFF2007A	8	20.6±0.5	16.0±0.5	10.0±0.15	7.7±0.25	8.9±0.2	6.65±0.15		44	30.3		1300
EFF1505	8	15.0±0.4	11.0±0.35	7.5±0.15	5.5±0.25	5.3±0.15	4.65±0.15	2.4±0.1	34	16	850	900
EFF1505A	8	15.0±0.5	11.0 min	7.5±0.15	5.5±0.25	5.3±0.15	4.65±0.15		34	15		900

EC CORES

Type	Fig	Dimensions(mm)							Effective Parameters		AL (nH)+30% -20%	
		A	B	C	D	E	F	G	Le(mm)	Ae(mm ²)	CF196	CF139
EC9030	4	90.0±1.8	68.5 min	45.0±0.65	35.5±0.5	30.0±1.0	30.0±1.0	6.0±0.3	221	626		5925
EC7017	4	70.0±1.7	44.5±1.2	34.5±0.3	22.75±0.45	16.4±0.4	16.4±0.4	4.75±0.25	144	279	4200	4400
EC4215	5	42.0±0.8	29.2 min.	22.4±0.3	15.4±0.3	15.5±0.3	15.5±0.4	-	99	203	4350	4500
EC4112	6	40.6±1.0	26.3±1.5	19.35±0.3	13.5±0.8	11.9±0.6	11.9±0.6	3.0±0.5	89	121	2900	3000
EC4013L	5	40.0±0.5	29.6 min.	24.0±0.2	17.0±0.25	13.25±0.25	13.4±0.20		105	147	3100	3300
EC4013	5	40.0±0.5	29.6 min.	22.32±0.2	15.75±0.2	13.25±0.25	13.4±0.20		102	147	3100	3200
EC3510	4	34.5±0.8	22.75±0.55	17.3±0.15	11.9±0.7	9.8±0.6	9.8±0.6	2.75±0.25	77	84	2200	2300

ETD CORES

Type	Fig	Dimension (mm)							Effective Parameters		AL (nH)+30% -20%	
		A	B	C	D	E	F	Le(mm)	Ae(mm ²)	CF196	CF139	
ETD5922	7	59.8±1.4	44.7±1.1	31.0±0.2	22.45±0.45	21.65±0.45	21.65±0.45	139	368	5700	5950	
ETD5419	7	54.5±1.3	41.2±1.1	27.6±0.2	20.2±0.4	18.9±0.4	18.9±0.4	127	280	4750	4850	
ETD4917	7	48.5±1.3 -0.9	36.1±1.8	24.9±0.4	18.5±0.3	16.7±0.8	16.7±0.8	114	211	3950	4100	
ETD4415	7	43.8±1.2-0.8	32.5±1.6	22.5±0.4	16.3 min	15.2±0.8	15.2±0.8	103	173	3600	3750	
ETD3913M	7	38.9±1.1-0.7	29.3±1.6	20.0±0.2	14.9±0.3	12.8±0.6	12.8±0.6	92.2	125	-	2950	
ETD3913	7	38.9±1.1-0.7	29.3±1.6	20.0±0.4	14.2 min	12.8±0.6	12.8±0.6	92	125	2850	2950	
ETD3913H	7	39.1±0.9	30.1±0.8	22.2±0.2	16.9±0.2	12.5±0.3	12.5±0.3	101.9	125.2	-	2700	
ETD3913L	7	39.0±0.5	29.3 min	21.2 min	15.9 min	12.5±0.3	12.5±0.3	96.4	127.9	-	3000	
ETD3411	7	34.0±1-0.6	25.6±1.4	17.5±0.4	11.8 min	11.1±0.6	11.1±0.6	78	97	2400	2500	
ETD3411A	7	34.0±1-0.6	25.6±1.4	13.0±0.13	7.8±0.13	10.8±0.23	10.8±0.23	63	98	3350	3450	
ETD2910	7	30.6 -1.6	22.0±1.4	16.0±0.4	10.7 +0.6	9.8±0.6	9.8±0.6	71	76	2250	2350	
ETD2910F	7	29.8±0.8	22.2±1.2	16.1±0.2	11.3±0.3	9.4±0.3-0.2	9.4±0.3-0.2	71	76	2250	2350	
ETD2910S	7	29.8±0.8	22.0min	16.5±0.2	11.5±0.2	9.5±0.3	9.5±0.3	72.9	76.7	-	2300	

EER CORES

Type	Fig	Dimension (mm)						Effective Parameters		AL (nH)+30% -20%	
		A	B	C	D	E	F	Le(mm)	Ae(mm ²)	CF196	CF139
EER5322	7	53.0±0.8	39.4±0.7	23.2±0.3	16.3±0.2	19.9±0.3	21.5±0.3	107	315	5950	6250
EER4518A	7	45.0±0.9	33.8±0.8	17.5±0.2	10.95±0.25	17.6±0.4	17.6±0.4	81	232	6150	6400
EER4320	7	42.8±0.6	32.8±0.5	21.4±0.2	15.5±0.2	17.3±0.25	19.6±0.3	98	233	5150	5300
EER4217	7	42.15±0.65	30.3±0.5	25.0±0.15	17.5±0.15	17.3±0.25	17.3±0.25	107	240	4500	4600
EER3913	7	39.0±1.4	28.6±1.0	22.2±0.2	17.0±0.25	12.8±0.2	12.8±0.2	101	131	2750	2850
EER3511	7	35.0±0.5	25.6±1.0	22.5±0.3	16.5±0.3	11.3±0.3	11.3±0.3	97	111	2600	2750
EER2811	7	28.5±0.6-0.5	21.2 min.	16.9±0.25	12.5±0.3-0.25	9.9±0.25	11.4±0.25	75	83	2300	2400
EER2811A	7	28.5±0.6-0.5	21.2 min.	14.0±0.2	9.65±0.25	9.9±0.25	11.4±0.25	64	82	2750	2900
EER2811B	7	28.5±0.6-0.5	21.2 min.	21.4±0.3	15.4±0.3	9.9±0.25	11.4±0.25	50	78	3300	3400

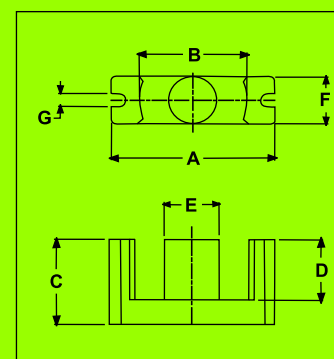

FIG 4

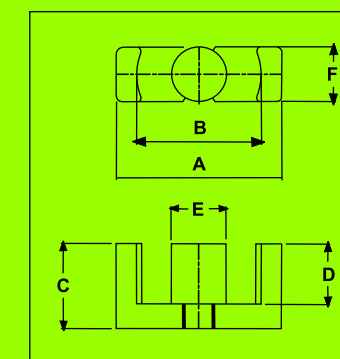

FIG 5

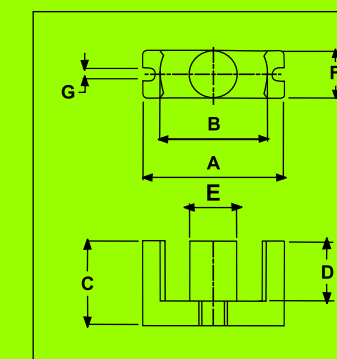

FIG 6

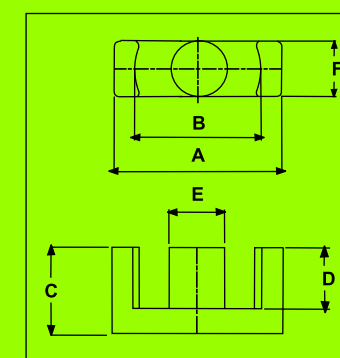

FIG 7

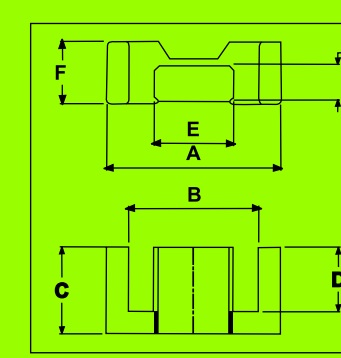

FIG 8



R M C O R E S

Type	Fig	Dimensions (mm)								Effective Parameters		AL (nH)+30% -20%					
		A	B1	B2	C	D	E	F	G	Le(mm)	Ae(mm ²)	CF196	CF139	CF140	CF130	CF195	CF199
RM14	10	41.6±0.6	17.0 min	29.5±0.5	15.05±0.15	10.55±0.15	14.75±0.25	34.3±0.5	18.7±0.3	70	200	5200	5450	-	6900	9300	-
RM12	10	36.75±0.65	13.4 min.	25.5±0.5	11.8±0.15	8.65±0.15	12.6±0.2	29.25±0.55	16.1±0.3	57.3	138	4800	5000	-	6500	9100	-
RM10	10	27.85±0.65	11.9 min.	21.65±0.45	9.35±0.15	6.35±0.15	10.7±0.2	24.15±0.55	13.2±0.3	44	98	4000	4200	-	5300	7100	-
RM8	10	22.75±0.45	9.8 min.	17.3±0.3	8.2±0.15	5.5±0.15	8.4±0.15	19.25±0.45	10.8±0.2	38	64	2500	2600	-	3100	3900	-
RM6	10	17.6±0.35	8.4 min	12.65±0.25	6.2±0.15	4.1±0.15	6.30±0.15	14.4±0.3	8.0±0.3	28.6	36.6	2000	2100	-	2600	3350	-
RM5	10	14.3±0.3	6.0 min.	10.4±0.2	5.2±0.1	3.25±0.1	4.8±0.12	12.05±0.25	6.6±0.2	23.2	24.8	1750	1850	2050	2350	3050	-
RM4	10	10.8±0.2	5.8 min	8.15±0.2	5.2±0.1	3.6±0.1	3.8±0.12	9.6±0.2	4.4 min	23.3	13.8	700	750	850	850	1000	-

P Q C O R E S

Type	Fig	Dimensions (mm)								Effective Parameters		AL (nH)+30% -20%			
		A	B1	B2	C	D	E	F	G	Le(mm)	Ae(mm ²)	CF196	CF139	CF195	CF199
PQ4040F	11	41.5±0.9	28.0 min	37.0±0.6	19.9±0.15	14.75±0.2	14.9±0.3	28.0±0.6	15.0 min	102	201	-	-	4200	-
PQ3238	11	33.0±0.50	19.0 min	27.5±0.50	19.15 ±0.15	14.85±0.15	13.5±0.25	22.0±0.50	11.6 min	93.5	165	3600	3700	-	-
PQ3230	11	33.0±0.5	19.0 min	27.5±0.5	15.15±0.15	10.65±0.15	13.5±0.25	22.0±0.5	11.6 min	74.7	167	4350	4550	-	-
PQ3220	11	33.0±0.5	19.0 min	27.5±0.5	10.3±0.15	5.75±0.15	13.5±0.25	22.0±0.5	11.6 min	55.9	169	5450	5650	-	-
PQ2625	11	27.3±0.46	15.5 min	22.5±0.46	12.35±0.15	8.05±0.15	12.0±0.2	19.0±0.45	10.5 min.	54.3	120	3950	4500	-	-
PQ2620	11	27.3±0.46	15.5min.	22.5±0.45	10.1±0.15	5.75±0.15	12.0±0.2	19.0±0.45	10.5 min.	48.3	121	4300	4500	-	-
PQ2616	11	27.3±0.46	15.5 min	22.5±0.46	8.3±0.15	3.95±0.15	12.0±0.2	19.0±0.45	10.5 min	27.1	109	-	5700	-	-
PQ2613	11	27.3±0.45	15.5 min	22.5±0.45	10.1±0.15	5.5 ±0.15	12.0±0.20	19.0±0.45	3.81±0.50	29	108	5300	5450	-	-
PQ2610	11	27.2±0.45	15.5 min	22.5±0.45	4.7±0.13	1.5±0.15	12.0±0.2	19.0±0.45	10.5 min.	27.1	105	5350	5500	-	-
PQ2609	11	27.25±0.45	15.5 min	22.5±0.40	4.7±0.13	1.47±0.15	11.99±0.45	19.0±0.45	10.8±0.25	25.5	127.8	6750	6900	-	-
PQ2020	11	21.3±0.4	12.0 min	18.0±0.4	10.1±0.13	7.15±0.15	8.8±0.2	14.0±0.4	7.9 min.	45.7	62.6	2700	2800	-	-
PQ2016	11	21.3±0.40	12.0 min	17.6 min	8.1±0.13	5.15±0.15	8.8±0.2	14.0±0.40	7.9 min	37.6	61.9	2600	2700	-	-
PQ2010	11	21.2±0.4	12.0 min	17.6 min	4.7±0.13	1.5±0.15	8.87±0.2	14.0±0.4	7.9 min.	22.7	62.5	3500	3600	-	-

P O T C O R E S

Type	Fig	Dimensions (mm)								Effective Parameters		AL (nH)+30% -20%					
		D1	D2	G	H1	H2	D3	D4	a	Le(mm)	Ae(mm ²)	CF196	CF139	CF140	CF130	CF195	
P3622	15	35.5±0.5	30.5±0.4	5.2±0.4	10.85±0.2	7.6±0.15	15.9±0.3	5.5±0.12	26.2±0.6	52	202	7400	7700	8800	10000	13700	
P3422H	15	34.0±0.5	30.0±0.5	5.2±0.4	10.8-0.5	7.8±0.3	15.7-0.8	4.65±0.15	24.2±0.6	53.5	194.8	7000	7300	8300	9450	13000	
P3019A	15	30.0±0.50	25.4±0.40	4.8±0.60	9.95±0.25	7.2±0.20	13.32±0.20	5.5±0.15	-	45.77	141.8	5600	5800	6500	7300	9800	
P3019	15	30.0±0.5	25.4±0.4	4.8±0.6	9.4±0.12	6.63±0.13	13.32±0.2	5.55±0.15	20.6±0.5	45.2	137	5600	5800	6600	7450	10100	
P2616	15	25.5±0.5	21.6±0.45	3.8±0.6	8.05±0.12	5.63±0.13	11.3±0.2	5.55±0.15	18.05±0.4	37.2	93	4400	5300	5800	6300	9400	
P2213	15	21.6±0.4	18.2±0.3	3.8±0.6	6.7±0.1	4.73±0.13	9.25±0.15	4.55±0.15	15.3±0.5	31.6	63	3300	3400	3800	4250	5500	
P2213M	15	21.6±0.4	18.2±0.3	3.8±0.6	6.7±0.1	4.73±0.13	9.25±0.15	5.5±0.15	15.3±0.5	31.6	63	-	3300	-	4100	5200	
P1811	15	18.0±0.5	15.2±0.25	3.4±0.6	5.25±0.1	3.72±0.13	7.45±0.15	3.1±0.12	12.85±0.5	25.9	43	2800	2900	3300	3700	4800	
P1408	15	14.0±0.2	11.8±0.2	3.8±0.6	4.15±0.15	2.9±0.15	5.9±0.15	3.1±0.12	8.9±0.3	19	25.8	2100	2150	2350	2600	3300	
P0903	15	9.15±0.5	7.62±0.13 -0.12	1.9±0.5	2.65±0.1	1.88±0.5	3.8±0.1	2.05±0.05	7.2±0.2	11.97	10.46	1200	1250	1350	1450	1750	

P T S C O R E S

Type	Fig	Dimensions (mm)								Effective Parameters		AL (nH)+30% -20%	
		A	B1	B2	C	D	E1	E2	F	Le(mm)	Ae(mm ²)	CF196	CF139
PT2311	13	22.9±0.45	18.3±0.35	3.8±0.6	5.5±0.15	3.8±0.15	9.7±0.2	5.1±0.15	15.2±0.3	28	61	3300	3500
TS2311	14	22.9±0.45	18.3±0.35	13.2 min.	5.5±0.15	3.8±0.15	9.7±0.2	5.1±0.15	15.2±0.3				
PT1811	13	17.9±0.3	15.1±0.25	3.8±0.6	5.3±0.15	3.7±0.15	7.4±0.15	3.1±0.12	11.9±0.3	27	40	2300	2400
TS1811	14	17.9±0.3	15.1±0.25	10.5 min.	5.3±0.15	3.7±0.15	7.4±0.15	3.1±0.12	11.9±0.3				
PT1408	13	14.0±0.2	11.8±0.2	3.3±0.6	4.15±0.15	2.9±0.15	5.9±0.15	3.1±0.12	9.4±0.3	21.1	23.3	1500	1600
TS1408	14	14.0±0.2	11.8±0.2	8.5 min	4.15±0.15	2.9±0.15	5.9±0.15	3.1±0.12	9.4±0.3				

*A_e measured by pairing PT and TS cores.

E P C O R E S

Type	Fig	Dimensions (mm)							Effective Parameters		AL (nH)+30% -20%			
		A	B1	C	D	E	F	G	Le(mm)	Ae(mm ²)	CF196	CF139	CF130	CF195
EP20	12	24.0±0.50	16.5±0.40	10.7±0.15	7.2±0.20	8.75±0.25	14.95±0.30	-	39.5	80	4050	4200	5500	7700
EP15	12	14.5±0.20	12.1±0.20	5.15±0.15	3.45±0.15	7.5±0.10	13.55±0.30	-	22.81	46.3	3500	3650	4600	6100
EP13	12	12.5±0.3	10.0±0.3	6.5±0.15	4.65±0.15	4.35±0.15	8.8±0.2	2.36±0.13	24.5	19.5	1400	1500	1850	2450
EP10	12	11.5±0.3	9.4±0.2	5.1±0.15	3.75±0.15	3.3±0.15	7.6±0.2	1.8±0.13	19.6	11.3	950	1000	1200	1600
EP7	12	9.2±0.2	7.4±0.2	3.75±0.15	2.65±0.15	3.3±0.15	6.35±0.15	1.7±0.1	15.7	10.3	1000	1050	1250	1600

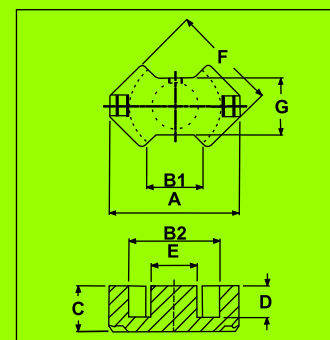

FIG. 10

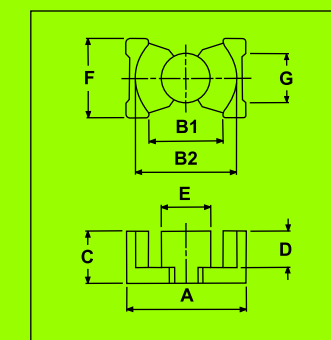

FIG. 11

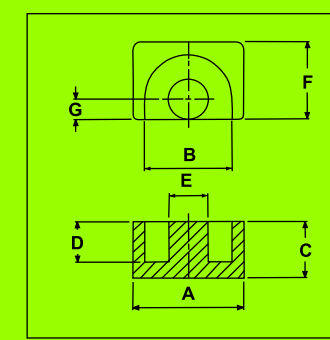

FIG. 12

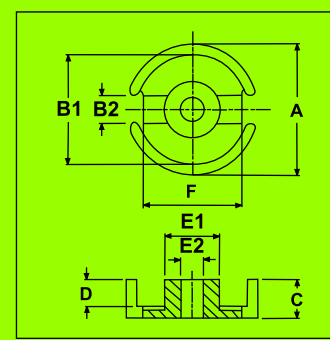

FIG. 13

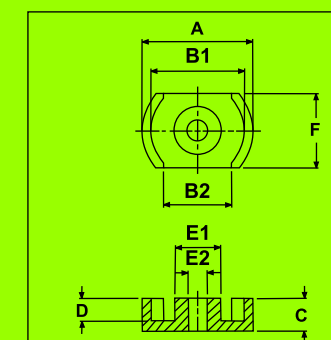

FIG. 14

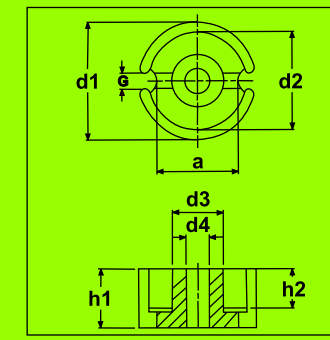

FIG. 15



ET & UT CORES

Type	Fig.	DIMENSIONS (mm)						Effective Parameters		AL (nH)+30% -20%	
		A	B	C	D	E	F	Le(mm)	Ae(mm ²)	CF195	CF197
ET 3535	22	35.3 ±0.6	26.8 min	35.3 ±0.6	26.8 min	7.4 ±0.25	7.4 ±0.25	86.9	57.1	4100	5750
ET2930	22	29.0 ±0.4	23.0 ±0.4	30.0 ±0.4	24.0 ±0.4	5.0 ±0.25	5.0 ±0.3	74.5	27.9	2350	3300
ET2828	22	28.4 ±0.5	22.2 min	28.4 ±0.5	22.2 min	5.0 ±0.3	5.0 ±0.3	70	27	2400	3400
ET2424	22	24.2 ±0.5	19.0 min	24.2 ±0.5	19.0 min	4.0 ±0.2	4.0 ±0.3	60	18	1900	2650
UT20	23	20.6 ±0.3	16.0 ±0.3	14.1 ±0.25	7.5 ±0.15	4.1 ±0.2	4.6 ±0.2	53	13	1550	2150
UT19	23	19.5 ±0.3	13.1 ±0.25	14.2 ±0.3	7.0 ±0.2	4.0 ±0.2	5.0 ±0.3	51.2	16	1950	2750

PLANER E CORES & PLATE

Type	Fig	DIMENSIONS (mm)							Effective Parameters			AL (nH)+30% -20%
		A	B	C	D	E	F	G	Le(mm)	Ae(mm ²)	CF139	
EE15330P	24	153.0±2.0	129±2.0	31±0.5	21±0.75	22±0.5	55±0.8		223.7	1163.1	12000	
EE6814P	24	68.0±1.3	55.6±1.1	13.5±0.15	6.5±0.15	12.15±0.15	50.8±1.0		89.9	671.5	14600	
EE 6450P I 6450P	24 25	64.0 ±1.3 64.0 ±1.3	53.6 ±1.1 50.8 ±1.1	10.2 ±0.15 5.1 ±0.15	5.1 ±0.15	10.2 ±0.2	50.8 ±1.1		80	519	13000 *14400	
EE6430P	24	64.0 ±1.30	53.6 ±1.1	15.1 ±0.15	10.02 ±0.25	10.15 ±0.20	50.8 ±1.10		99.30	521.30	10000	
EE6423P	24	64.0±1.30	53.6 ±1.1	11.6±0.15	6.5±0.15	10.15 ±0.20	50.8 ±1.10		85.5	246.9	5500	
EE6420P	24	64.0 ±1.30	53.6 ±1.1	10.2 ±0.20	5.17 ±0.20	10.15 ±0.20	50.8 ±1.10		80	508.50	14800	
EE6415P	24	64.0 ±1.30	53.6 ±1.1	15.0 ±0.15	9.9 ±0.15	10.2 ±0.35	51.0 ±1.20		99.10	520.50	11000	
EE5811P	24	8.4 ±1.2 5	50.0 min	10.5 ±0.15	6.5 ±0.15	8.1 ±0.2	38.1 ±0.8		80.6	308.4	7500	
EE 4328P I 4328P	24 25	43.2 ±0.9 43.2 ±0.9	34.7 min 27.9 ±0.6	9.5 ±0.15 4.1 ±0.20	5.4 ±0.15	8.1 ±0.2	27.9 ±0.6		61.5	226.8	8300 *9450	
EE4311P	24	43.2 ±0.90	34.7 min	11.0 ±0.15	6.9 ±0.15	8.1 ±0.20	27.9 ±0.60		67.10	229.00	8300	
EE 3825P I 3825P	24 25	38.1 ±0.76 38.1 ±0.76	30.23 min 25.4 ±0.51	8.26 ±0.2 3.81 ±0.2	4.45 ±0.2	7.6 ±0.2	25.4 ±0.51	3.8±2	52.6	194	7300 *8500	
EE 3220P I 3220P	24 25	31.75 ±0.64 31.75 ±0.64	24.9 min 20.32 ±0.4	6.35 ±0.15 3.18 ±0.2	3.18 ±0.2	6.35 ±0.15	20.32 ±0.4	3.18±0.2	41.7	129	6200 *6400	
EE 2208P	24	21.8 ±0.4	16.8 ±0.4	3.95 ±0.15	1.75 ±0.15	5.0 ±0.15	7.9 ±0.25		26.1	36.5	2850	
EE2206P	24	21.8 ±0.40	16.8 ±0.40	5.7 ±0.10	3.2 ±0.10	5.0 ±0.10	15.8 ±0.30	2.5 ±0.10	32.50	79.00	5200	
EE 1804P I 1804P	24 25	18.0 ±0.35 18.0 ±0.35	14.0 ±0.3 10.0 ±0.2	4.0 ±0.1 2.0 ±0.1	2.0 ±0.1	4.0 ±0.1	10.0 ±0.2		24.3	40	2700 *2850	
EE15330P	24	153.0±1.0	129±1.0	31±0.25	20±.25	22.0±0.5	55.0±0.4		221.4	1141.9	11400	
EE3207P	24	31.75±.64	24.9 min	7.0±.15	3.8±0.2	6.35±.15	20.32±0.4		41.7	130.9	5700	
EE6440P	24	64±1.3	53.6±1.1	20±.15	15±.25	10.15±0.2	50.8±1.1		119.3	515.7	9800	
EE3211P	24	31.75±0.64	24.9 min	11.0±0.15	7.8±0.2	6.35±0.15	20.32±0.4		60.1	130.9	5400	

PLANER EH CORES & PLATE

Type	Fig.	DIMENSIONS (mm)							Effective Parameters		AL (nH)+30% -20%
		A	B	C	D	E1	F	E2	Le(mm)	Ae(mm ²)	
EEH 2506 I 2506	26 27	25.0 ±0.45 25.0 ±0.45	20.83 ±0.35 20.0 ±0.35	6.29 ±0.15 2.29 ±0.1	4.0 ±0.15	6.32 ±0.15	20.0 ±0.35	14.54 ±0.25	38	86	4450 *5300
EEH 2504 I 2504	26 27	25.0 ±0.45 25.0 ±0.45	20.83 ±0.35 20.0 ±0.35	4.29 ±0.1 2.29 ±0.1	2.0 ±0.1	6.32 ±0.15	20.0 ±0.35	14.54 ±0.25	30	86	5300 *5900
EEH 2204 I 2204	26 27	22.0 ±0.4 22.0 ±0.4	18.33 ±0.35 17.6 ±0.3	4.02 ±0.1 2.02 ±0.1	2.0 ±0.1	5.56 ±0.15	17.6 ±0.3	12.79 ±0.25	27	66	4600 *5200

A_i measured in Combination of I Core with E-Core

PM CORES

Type	Fig.	DIMENSIONS (mm)								Effective Parameters		AL (nH)+30% -20%
		A	B1	B2	C	D	E1	E2	F	Le(mm)	Ae(mm ²)	
PM 8770	28	85.5 ±1.5	68.15 ±1.05	41.0 ±1.5	34.8 ±0.25	24.4 ±0.4	31.2 ±0.5	8.65±0.25	35.0 ±1.0	146	910	12500
PM 6249	28A	61.0 ±1.0	49.5 ±0.75	29.0 min	24.4 ±0.15	16.9 ±0.2	25.1 ±0.4	5.5 ±0.1	28.5 max	109	570	9200
PM5039	28A	50.0-1.7	39.65±0.65	23.4 min	19.4±0.15	13.4±0.2	19.7±0.3	5.5±0.2	23.0 max	84	370	7200

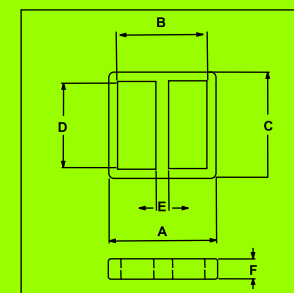

FIG. 22

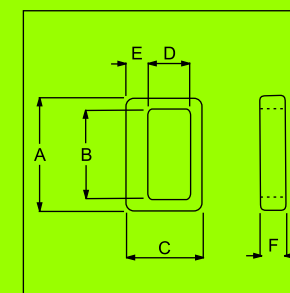

FIG. 23

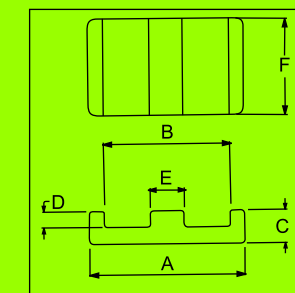

FIG. 24

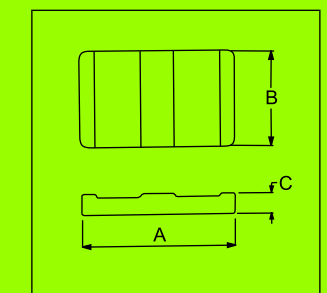

FIG. 25

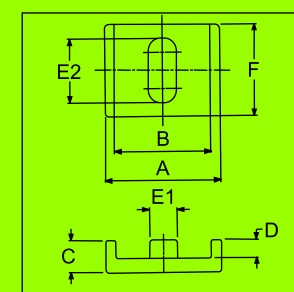

FIG. 26

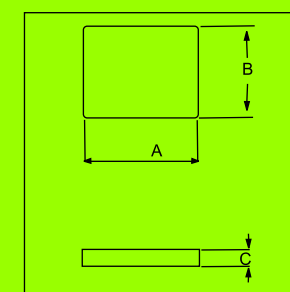

FIG. 27

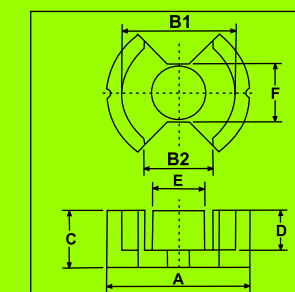

FIG. 28

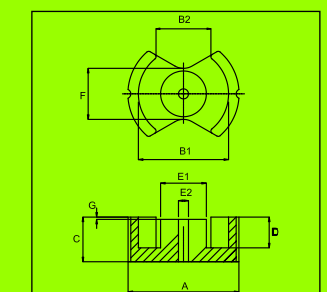

FIG. 28A



ROD CORES

Geometry	FIG	Dimensions (mm)	
		A	B
R1611	29	16.3±0.40	10.5±0.15
R1609	29	16.3±0.40	9.3±0.15
R1025	29	25.0±0.5	10±0.5
R1011	29	11.0±0.5	10±0.5
R0832	29	32.0 ±0.8	7.95±0.25
R0630	29	30.0±0.5	6.0±0.2
R0625	29	25.0±0.25	6.0±0.15
R0620	29	20.0±0.2	5.9±0.15
R0615	29	15.0±0.20	5.9±0.15
R0420	29	20.0±0.5	4.0±0.25
R0415	29	15.0±0.50	4.0±0.25
R0325	29	25.0±0.50	3.41±0.25
R0312	29	12 ±0.25	3.0±0.15

DISC CORES

Geometry	FIG	Dimensions (mm)	
		A	B
R3104	30	31.2±0.50	4.26 ±0.06
R3105	30	31.2±0.50	5.4 ±0.06
R3105A	30	31.2±0.50	5.0 ±0.06
R4008	30	40.0±1.30	7.5 ±0.10

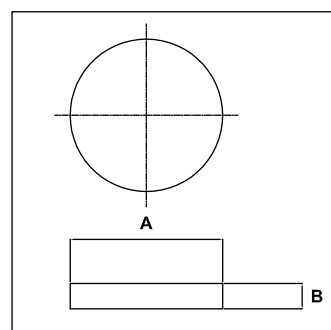

FIG. 30

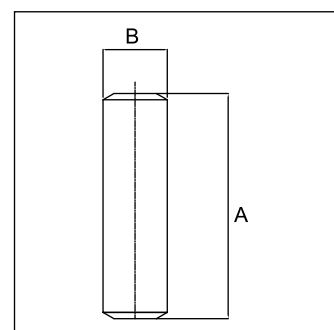
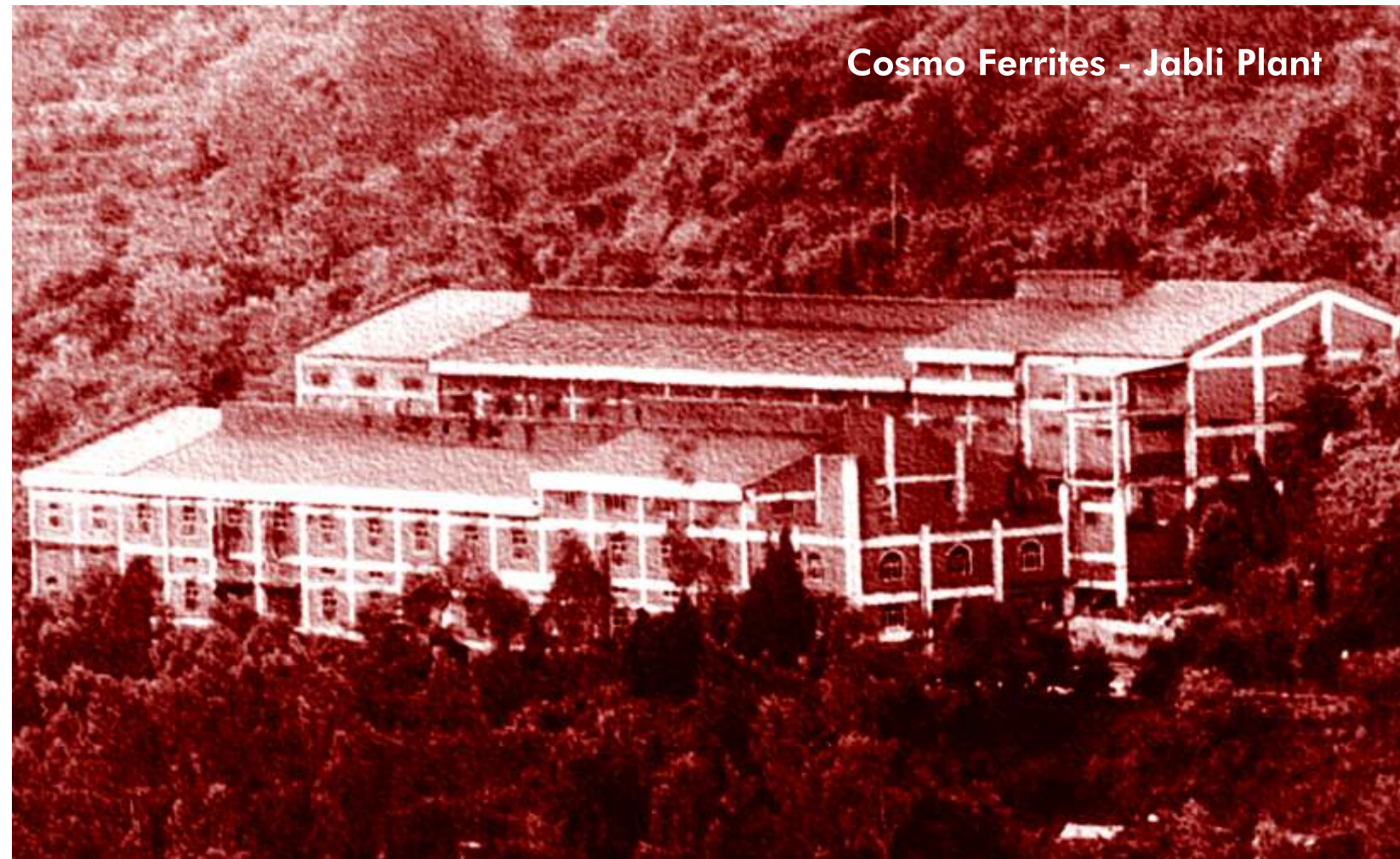

FIG. 29

Cosmo Ferrites - Jabli Plant



Govt. of India Recognized Export House

DSIR Approved In House R&D

An ISO 9001 & 14001 Accredited Company

RoHS Compliance Material

UL Approved Coated Products

Eco-Friendly Packaging material